	Product Information CDLK32-60/6-2	Manufacturer	CNP
		Address	Yuhang District, Hangzhou, Zhejiang,
Project Name		Contact	86-571-88637351
		Date	2022/07/17
Item NO		Client Name	DPA
		Client Addr.	
		Contacts	Alireza
		Contact	

Part NO.	1100057091
----------	------------

Product Picture	Note
	<p>Product introduction</p> <p>CDLK/CDLKF is non-self priming multi-stage centrifugal pump installed with standard motor. The motor shaft is directly connected with the pump shaft through coupling. The impellers and diffusers are made of stainless steel plate stamping and welding. In order to meet the requirement of installation depth of the water tank or vessel, it is possible to install cavity diffusers for changing length of the pump.</p> <p>Performance and advantages</p> <p>Compact structure Convenient maintenance Changeable installation depth</p>

technology	
Pump rotator speed	2900
Nameplate standards	CE
Material	
Impeller	304
Rubber code	P
Material Code	S
Medium	
Medium Temperature normal	-15+70
Medium Temperature high t	-15+105
Maximum Environment Temper	40
Motor	
Number of Motor Phase	Three Phase
Protection Class	IP55
Insulation Class	F
Motor Power	11KW
Power Frequency	50HZ
Rated Voltage (V)	380V
Rated Current (A)	21.0A
Energy Efficiency Level	IE3
Seal	
Mechanical Seal	CDLA-22/WSF14
Others	
Weight (kg)	152



Performance Curve CDLK32-60/6-2

Manufacturer	CNP
Address	Yuhang District, Hangzhou, Zhejiang,
Contact	86-571-88637351
Date	2022/07/17
Client Name	DPA
Client Addr.	
Contacts	Alireza
Contact	

Project Name	
Item NO	

The hydraulic performance curve have been tested with Clean Water at 20°C, density 1000kg/m³, and at 1bar atmospheric pressure. ISO99062012 Grade 3B

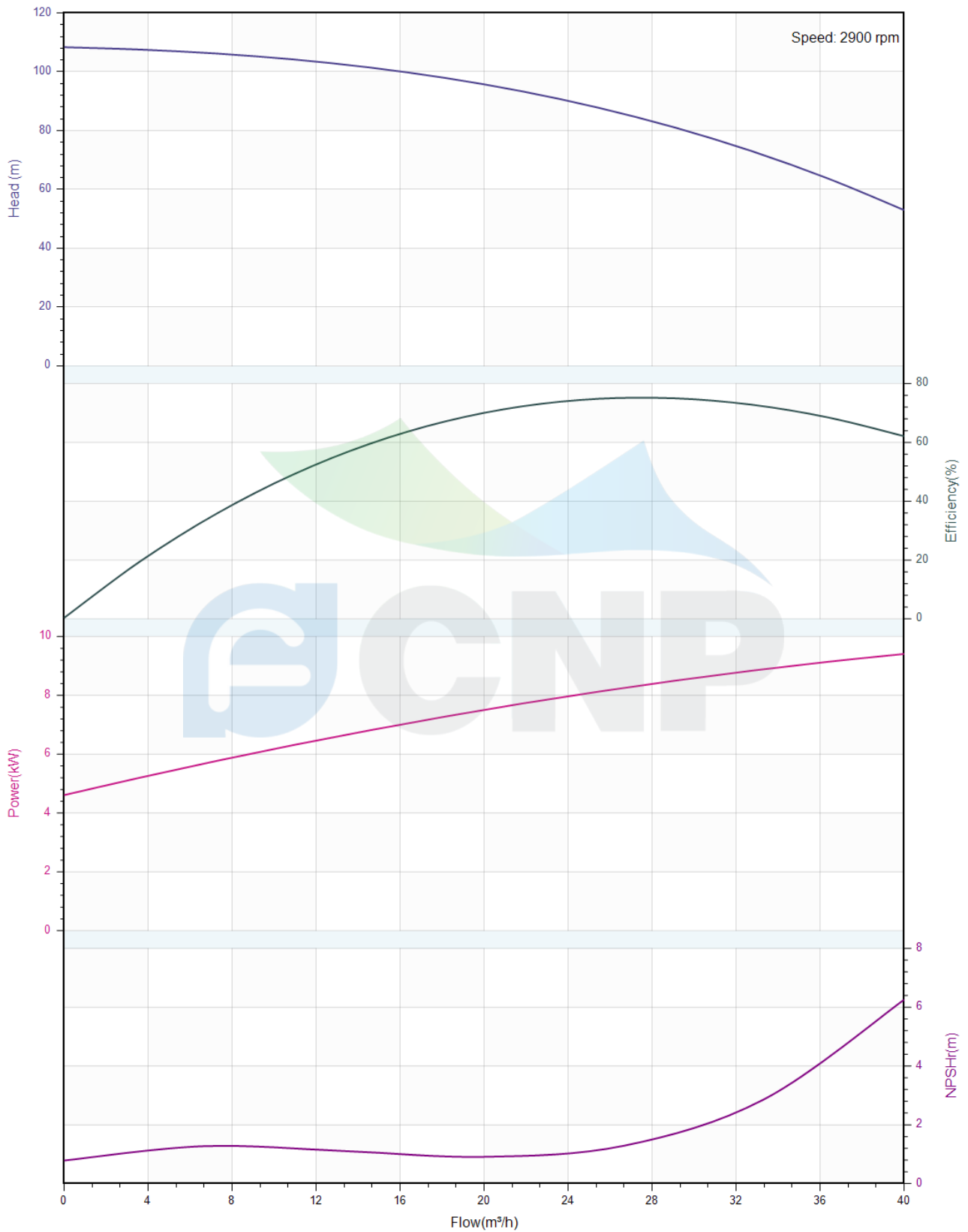



Pump Technical Parameters CDLK32-60/6-2

Manufacturer	CNP
Address	Yuhang District, Hangzhou, Zhejiang,
Contact	86-571-88637351
Date	2022/07/17
Client Name	DPA
Client Addr.	
Contacts	Alireza
Contact	

Rated parameters

Pump model	CDLK32-60/6-2
Part NO.	1100057091
Rated flow (m ³ /h)	32
Rated head (m)	74
Rated efficiency (%)	69
Power (kW)	9.35
NPSHr (m)	3
Speed (rpm)	2900
Max impeller diameter (mm)	118.2

Medium

Pumped medium	Clean Water
Working temperature (°C)	20
Medium density (kg/m ³)	1000
Viscosity (mm ² /s)	1

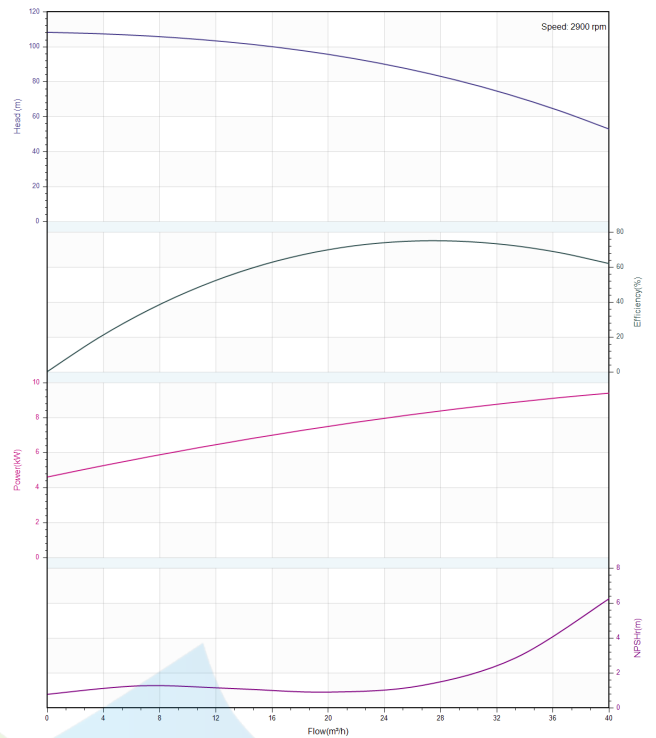

	Structure picture CDLK32-60/6-2	Manufacturer	CNP
		Address	Yuhang District, Hangzhou, Zhejiang,
		Contact	86-571-88637351
		Date	2022/07/17
		Client Name	DPA
Project Name		Client Addr.	
Item NO		Contacts	Alireza
		Contact	

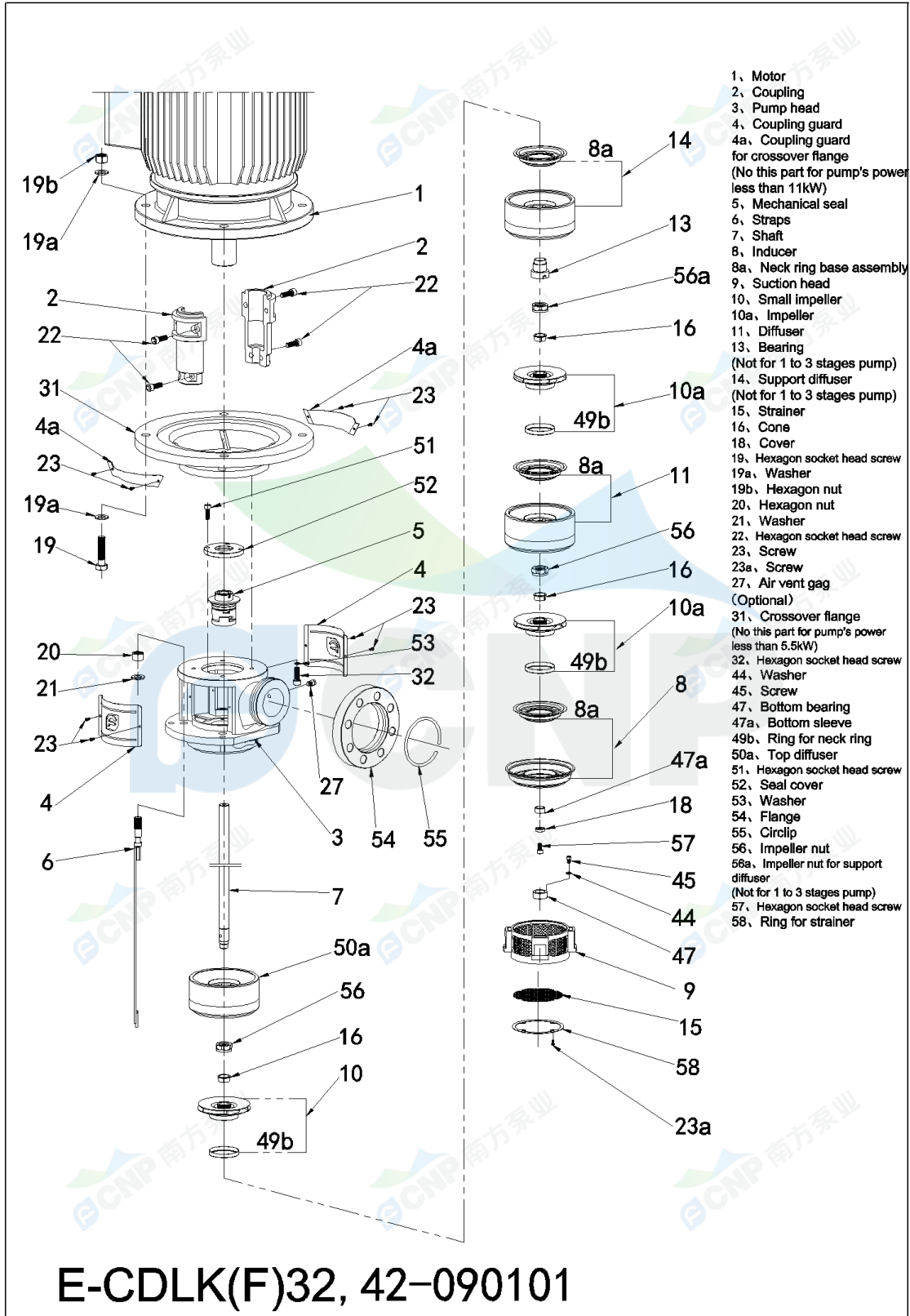



Dimension Drawing
CDLK32-60/6-2

Manufacturer	CNP
Address	Yuhang District, Hangzhou, Zhejiang,
Contact	86-571-88637351
Date	2022/07/17
Client Name	DPA
Client Addr.	
Contacts	Alireza
Contact	

Project Name

Item NO

CDLK(F)32-60/6-2 50Hz
CDLK(F)32-60/6 50Hz

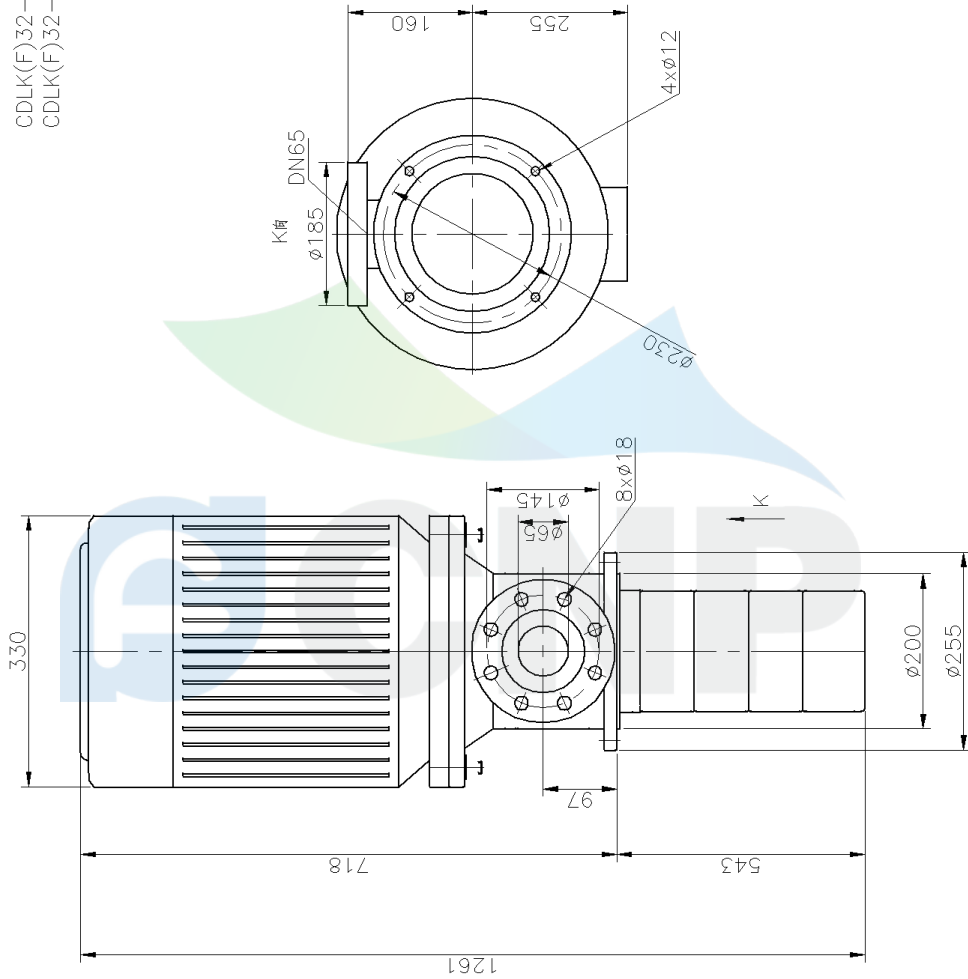

描图
描校
旧底图总号
底图总号
签字
日期