	Product Information 80WQ/H55-26-7.5	Manufacturer	CNP
		Address	Yuhang District, Hangzhou, Zhejiang,
Project Name		Contact	86-571-88637351
		Date	2022/03/08
Item NO		Client Name	DPA
		Client Addr.	
		Contacts	Alireza
		Contact	

Part NO.	1100200994
----------	------------

Product Picture	Note
	<p>The product adopts a brand-new hydraulic design, which has the characteristics of high efficiency and energy saving, stable operation, strong passing capacity, simple structure, convenient disassembly and maintenance, diverse installation methods, and high reliability.</p>

technology	
Pump rotator speed	2920
Nameplate standards	CE
Pump version	1
Material	
Impeller	HT200
Installation	
Installation type	Verital
Medium	
Medium Temperature	-0+40
Maximum Environment Temper	40
Structure dimension	
Inlet & outlet size types	DN
Outlet Diameter	80
Rotation Direction	Anti-clockwise
Motor	
Number of Motor Phase	Three Phase
Protection Class	IPX8
Insulation Class	F
Motor Power	7.5
Seal	
Mechanical Seal	H-30
Others	
Weight (kg)	91



Performance Curve 80WQ/H55-26-7.5

Manufacturer	CNP
Address	Yuhang District, Hangzhou, Zhejiang,
Contact	86-571-88637351
Date	2022/03/08
Client Name	DPA
Client Addr.	
Contacts	Alireza
Contact	

Project Name

Item NO

The hydraulic performance curve have been tested with Clean Water at 20°C, density 1000kg/m³, and at 1bar atmospheric pressure. ISO99062012 Grade 3B

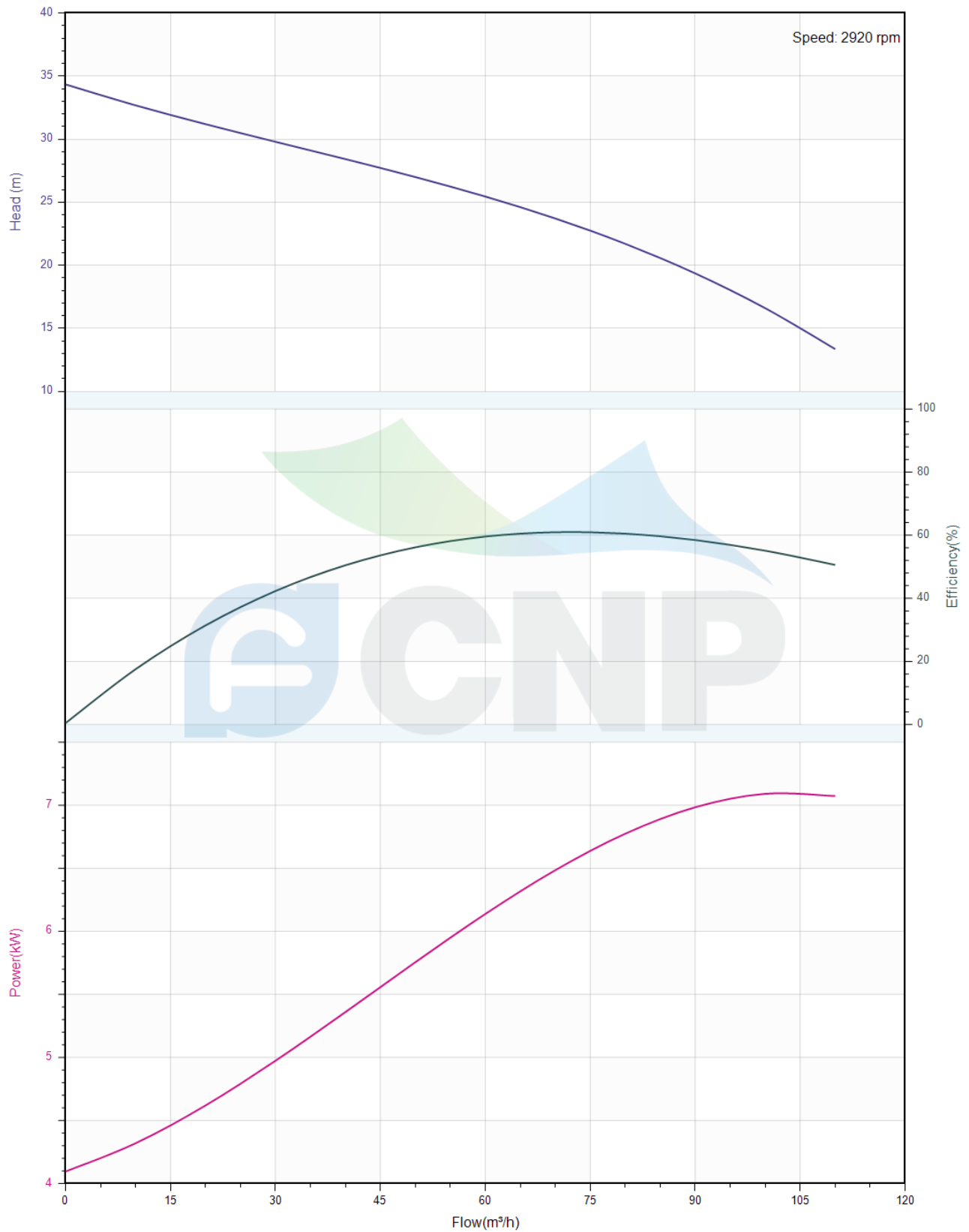



Pump Technical Parameters 80WQ/H55-26-7.5

Manufacturer	CNP
Address	Yuhang District, Hangzhou, Zhejiang,
Contact	86-571-88637351
Date	2022/03/08
Client Name	DPA
Client Addr.	
Contacts	Alireza
Contact	

Rated parameters

Pump model	80WQ/H55-26-7.5
Part NO.	1100200994
Rated flow (m ³ /h)	55
Rated head (m)	26
Rated efficiency (%)	65.2
Power (kW)	5.977
Speed (rpm)	2920
Max impeller diameter (mm)	162.5

Medium

Pumped medium	Clean Water
Working temperature (°C)	20
Medium density (kg/m ³)	1000
Viscosity (mm ² /s)	1

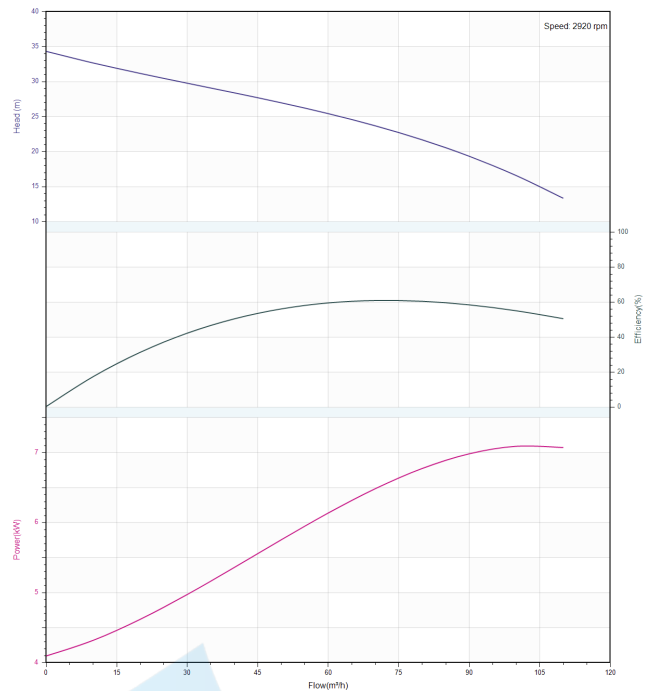

	Structure picture 80WQ/H55-26-7.5	Manufacturer	CNP
		Address	Yuhang District, Hangzhou, Zhejiang,
Project Name		Contact	86-571-88637351
		Date	2022/03/08
Item NO		Client Name	DPA
		Client Addr.	
		Contacts	Alireza
		Contact	

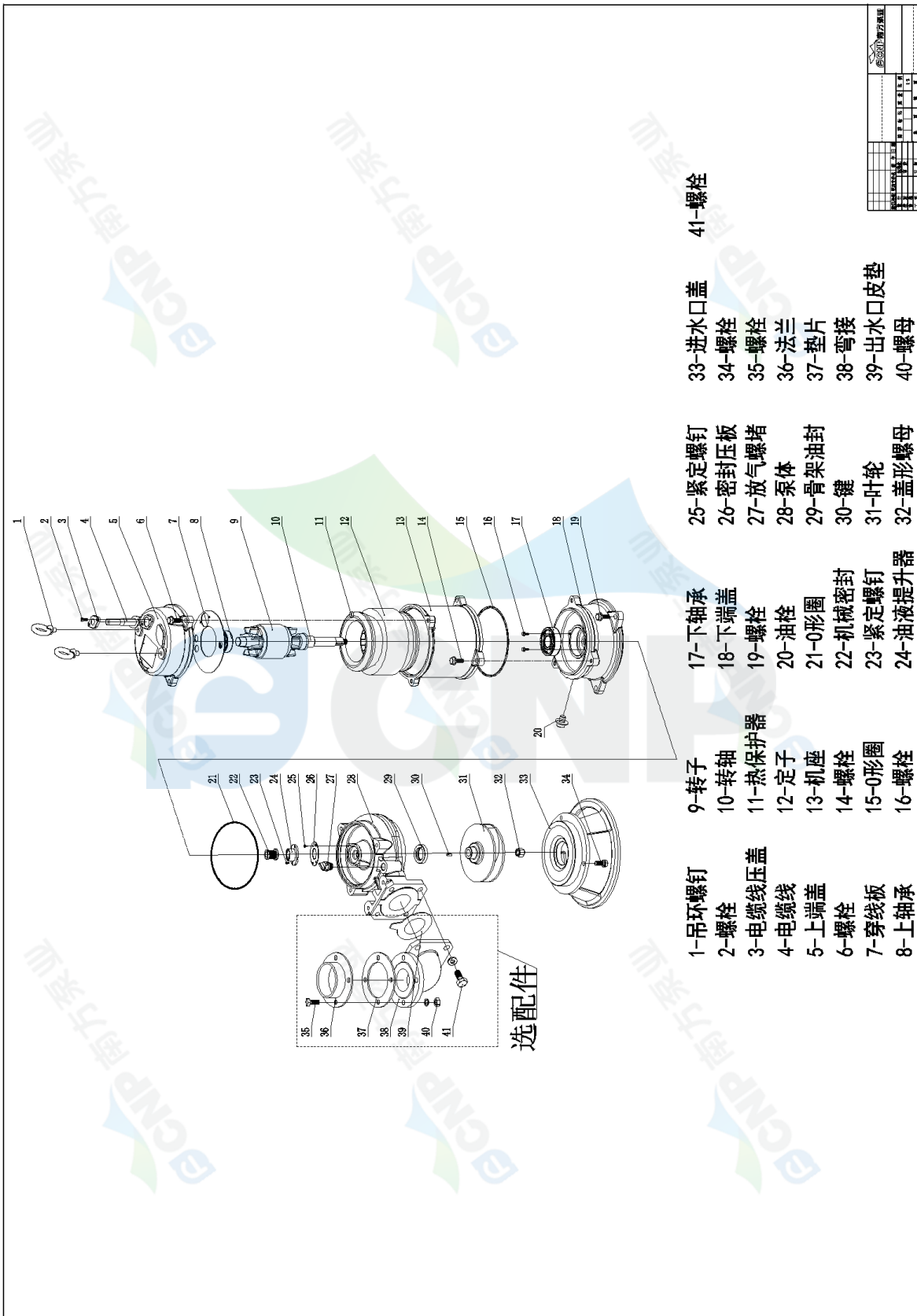

	Dimension Drawing 80WQ/H55-26-7.5	Manufacturer	CNP
		Address	Yuhang District, Hangzhou, Zhejiang,
Project Name		Contact	86-571-88637351
		Date	2022/03/08
Item NO		Client Name	DPA
		Client Addr.	
		Contacts	Alireza
		Contact	

移动式安装尺寸图

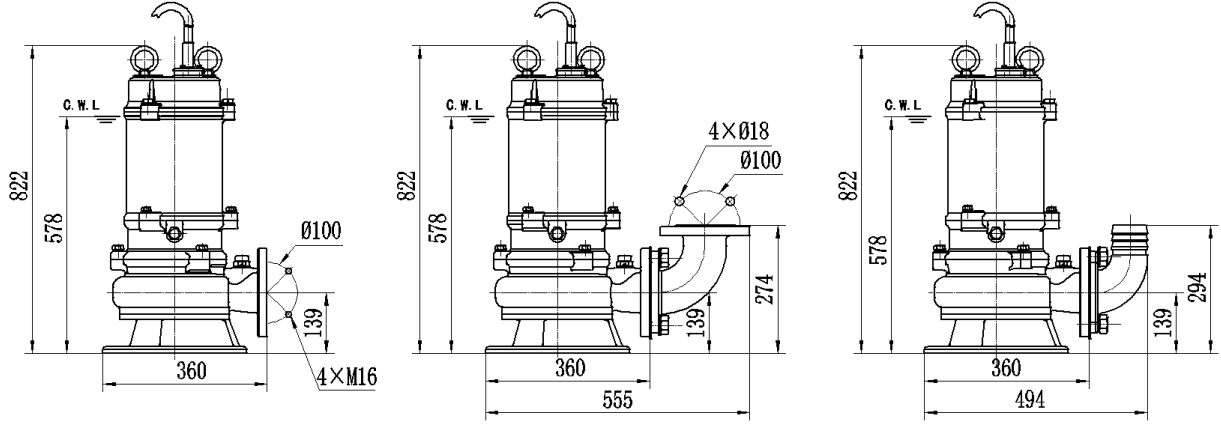

注：C.W.L为连续运行允许最低液位。

自动耦合式安装尺寸图

