	<b>Product Information</b> <b>50WQ/H20-7-0.75</b>	Manufacturer	CNP
		Address	Yuhang District, Hangzhou, Zhejiang,
Project Name		Contact	86-571-88637351
		Date	2022/03/08
Item NO		Client Name	DPA
		Client Addr.	
		Contacts	Alireza
		Contact	

Part NO.	1100196990
----------	------------

Product Picture	Note
	<p>The product adopts a brand-new hydraulic design, which has the characteristics of high efficiency and energy saving, stable operation, strong passing capacity, simple structure, convenient disassembly and maintenance, diverse installation methods, and high reliability.</p>

<b>technology</b>	
Pump rotator speed	2825
Nameplate standards	CE
Pump version	1
<b>Material</b>	
Impeller	HT200
<b>Installation</b>	
Installation type	Verital
<b>Medium</b>	
Medium Temperature	-0+40
Maximum Environment Temper	40
<b>Structure dimension</b>	
Inlet & outlet size types	DN
Outlet Diameter	50
Rotation Direction	Anti-clockwise
<b>Motor</b>	
Number of Motor Phase	Three Phase
Protection Class	IPX8
Insulation Class	F
Motor Power	0.75
<b>Seal</b>	
Mechanical Seal	H-17
<b>Others</b>	
Weight (kg)	27



### Performance Curve 50WQ/H20-7-0.75

Manufacturer	CNP
Address	Yuhang District, Hangzhou, Zhejiang,
Contact	86-571-88637351
Date	2022/03/08
Client Name	DPA
Client Addr.	
Contacts	Alireza
Contact	

Project Name

Item NO

The hydraulic performance curve have been tested with Clean Water at 20°C, density 1000kg/m<sup>3</sup>, and at 1bar atmospheric pressure. ISO99062012 Grade 3B

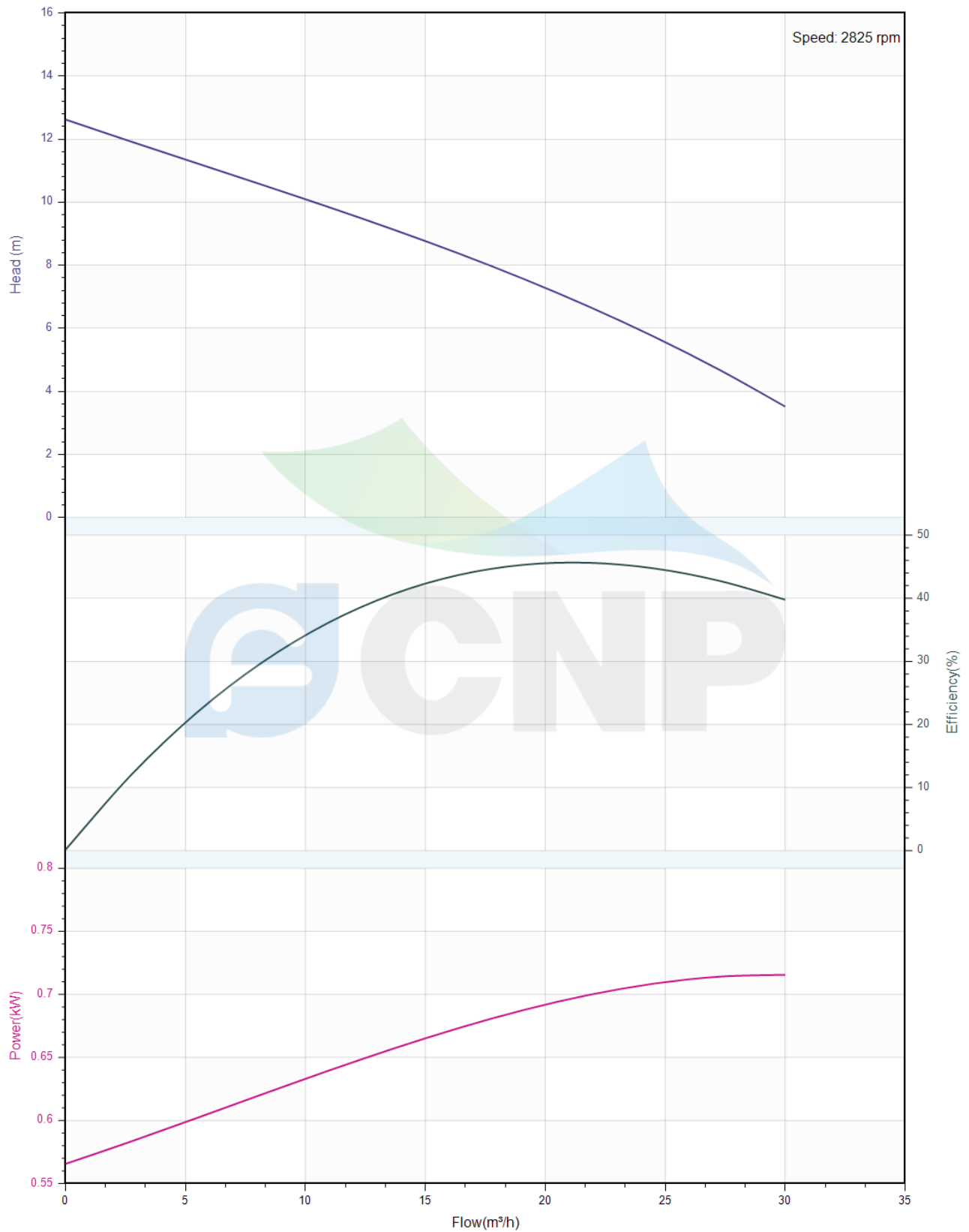



## Pump Technical Parameters 50WQ/H20-7-0.75

Manufacturer	CNP
Address	Yuhang District, Hangzhou, Zhejiang,
Contact	86-571-88637351
Date	2022/03/08
Client Name	DPA
Client Addr.	
Contacts	Alireza
Contact	

### Rated parameters

Pump model	50WQ/H20-7-0.75
Part NO.	1100196990
Rated flow (m <sup>3</sup> /h)	20
Rated head (m)	7
Rated efficiency (%)	57.5
Power (kW)	0.664
Speed (rpm)	2825
Max impeller diameter (mm)	101

### Medium

Pumped medium	Clean Water
Working temperature (°C)	20
Medium density (kg/m <sup>3</sup> )	1000
Viscosity (mm <sup>2</sup> /s)	1

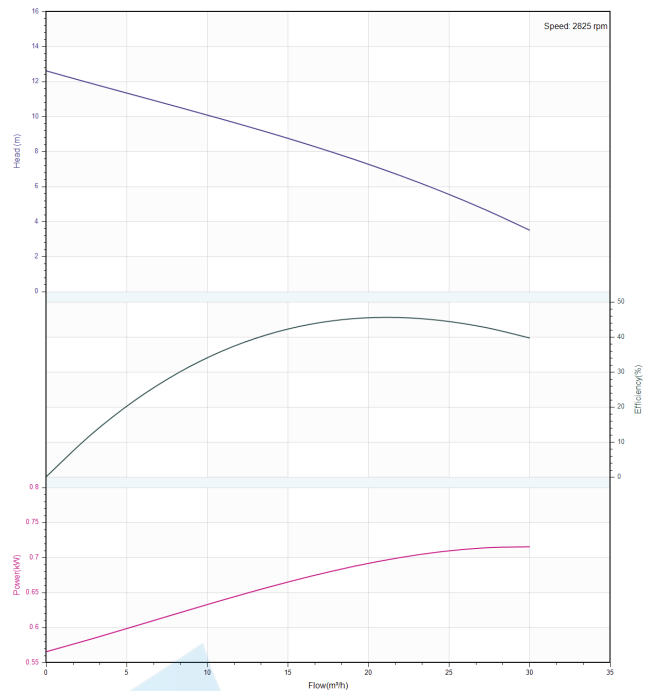

	<b>Structure picture</b> <b>50WQ/H20-7-0.75</b>	Manufacturer	CNP
		Address	Yuhang District, Hangzhou, Zhejiang,
Project Name		Contact	86-571-88637351
		Date	2022/03/08
Item NO		Client Name	DPA
		Client Addr.	
		Contacts	Alireza
		Contact	

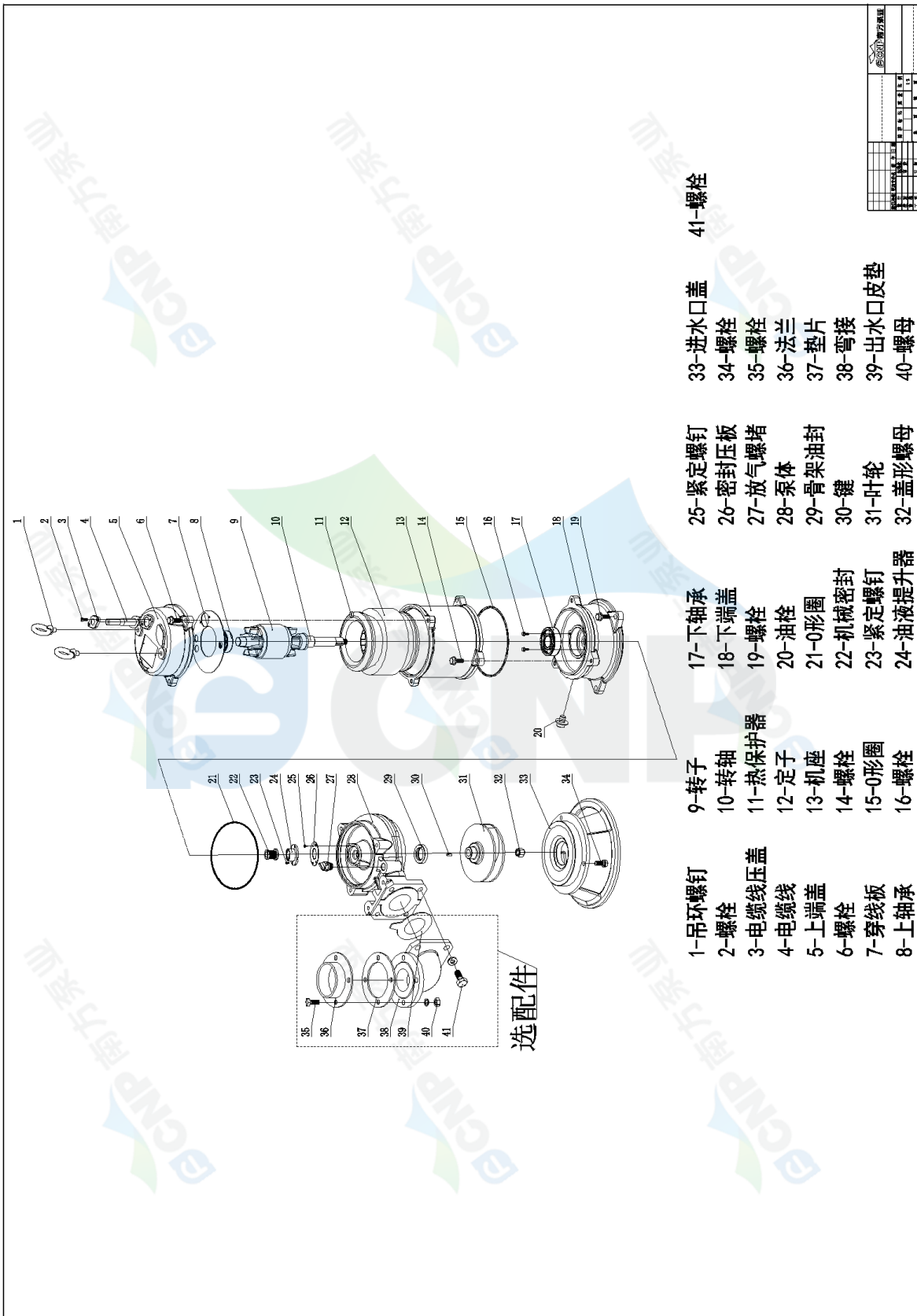

	<b>Dimension Drawing</b> <b>50WQ/H20-7-0.75</b>	Manufacturer	CNP
		Address	Yuhang District, Hangzhou, Zhejiang,
Project Name		Contact	86-571-88637351
		Date	2022/03/08
Item NO		Client Name	DPA
		Client Addr.	
		Contacts	Alireza
		Contact	

### 移动式安装尺寸图

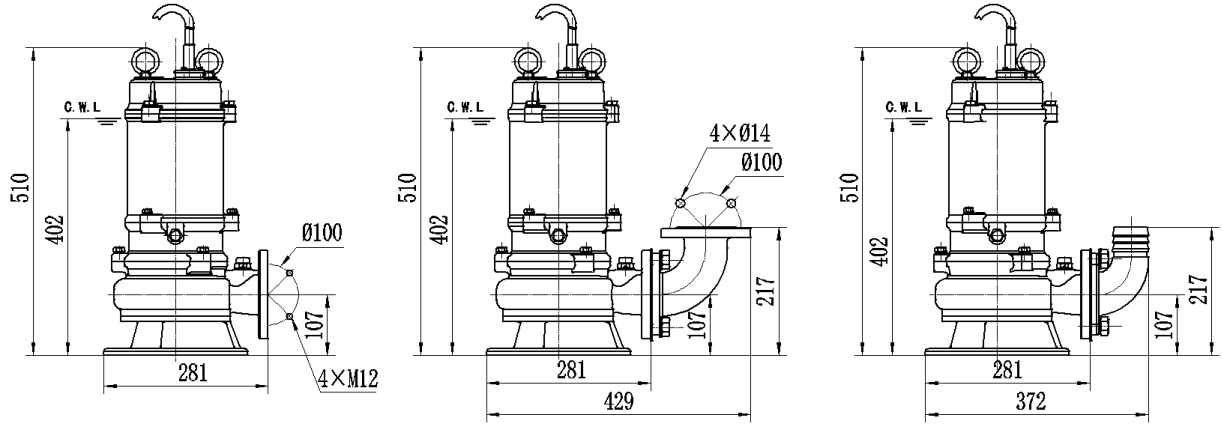

注：C.W.L为连续运行允许最低液位。

### 自动耦合式安装尺寸图

