



| | | | |
|--|--|--------------|--------------------------------------|
|  | Product Information 100WQ/H130-10-5.5 | Manufacturer | CNP |
| | | Address | Yuhang District, Hangzhou, Zhejiang, |
| | | Contact | 86-571-88637351 |
| | | Date | 2022/03/08 |
| Project Name | | Client Name | DPA |
| | | Client Addr. | |
| Item NO | | Contacts | Alireza |
| | | Contact | |

| | |
|----------|------------|
| Part NO. | 1100196989 |
|----------|------------|

| | |
|---|--|
| Product Picture | Note |
|  | <p>The product adopts a brand-new hydraulic design, which has the characteristics of high efficiency and energy saving, stable operation, strong passing capacity, simple structure, convenient disassembly and maintenance, diverse installation methods, and high reliability.</p> |

| | |
|----------------------------|----------------|
| technology | |
| Pump rotator speed | 2920 |
| Nameplate standards | CE |
| Pump version | 1 |
| Material | |
| Impeller | HT200 |
| Installation | |
| Installation type | Verital |
| Medium | |
| Medium Temperature | -0+40 |
| Maximum Environment Temper | 40 |
| Structure dimension | |
| Inlet & outlet size types | DN |
| Outlet Diameter | 100 |
| Rotation Direction | Anti-clockwise |
| Motor | |
| Number of Motor Phase | Three Phase |
| Protection Class | IPX8 |
| Insulation Class | F |
| Motor Power | 5.5 |
| Seal | |
| Mechanical Seal | H-30 |
| Others | |
| Weight (kg) | 90 |



Performance Curve 100WQ/H130-10-5.5

| | |
|--------------|--------------------------------------|
| Manufacturer | CNP |
| Address | Yuhang District, Hangzhou, Zhejiang, |
| Contact | 86-571-88637351 |
| Date | 2022/03/08 |
| Client Name | DPA |
| Client Addr. | |
| Contacts | Alireza |
| Contact | |

Project Name

Item NO

The hydraulic performance curve have been tested with Clean Water at 20°C, density 1000kg/m³, and at 1bar atmospheric pressure. ISO99062012 Grade 3B

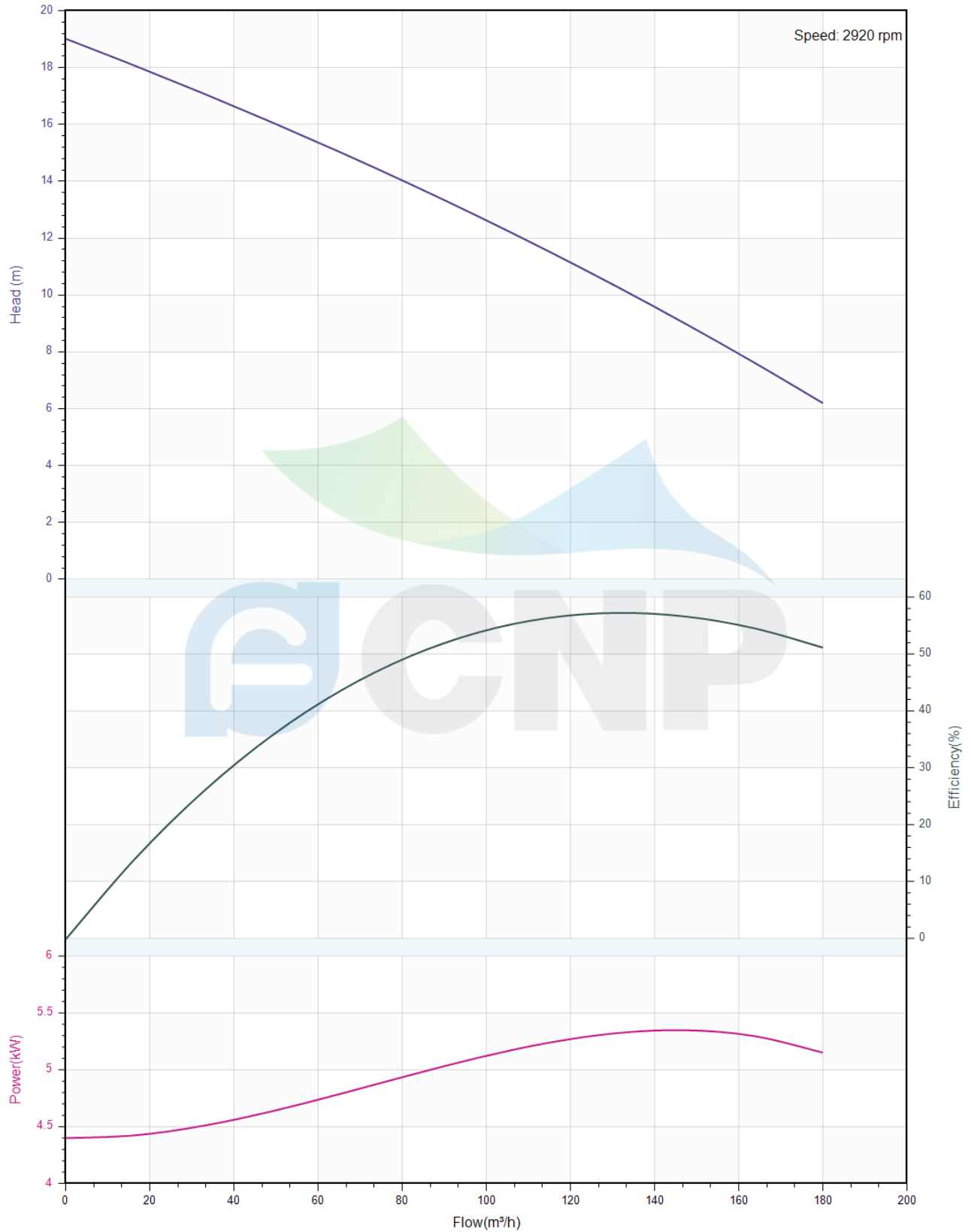



Pump Technical Parameters 100WQ/H130-10-5.5

| | |
|--------------|--------------------------------------|
| Manufacturer | CNP |
| Address | Yuhang District, Hangzhou, Zhejiang, |
| Contact | 86-571-88637351 |
| Date | 2022/03/08 |
| Client Name | DPA |
| Client Addr. | |
| Contacts | Alireza |
| Contact | |

Rated parameters

| | |
|--------------------------------|-------------------|
| Pump model | 100WQ/H130-10-5.5 |
| Part NO. | 1100196989 |
| Rated flow (m ³ /h) | 130 |
| Rated head (m) | 10 |
| Rated efficiency (%) | 67.6 |
| Power (kW) | 5.24 |
| Speed (rpm) | 2920 |
| Max impeller diameter (mm) | 140 |

Medium

| | |
|-------------------------------------|-------------|
| Pumped medium | Clean Water |
| Working temperature (°C) | 20 |
| Medium density (kg/m ³) | 1000 |
| Viscosity (mm ² /s) | 1 |

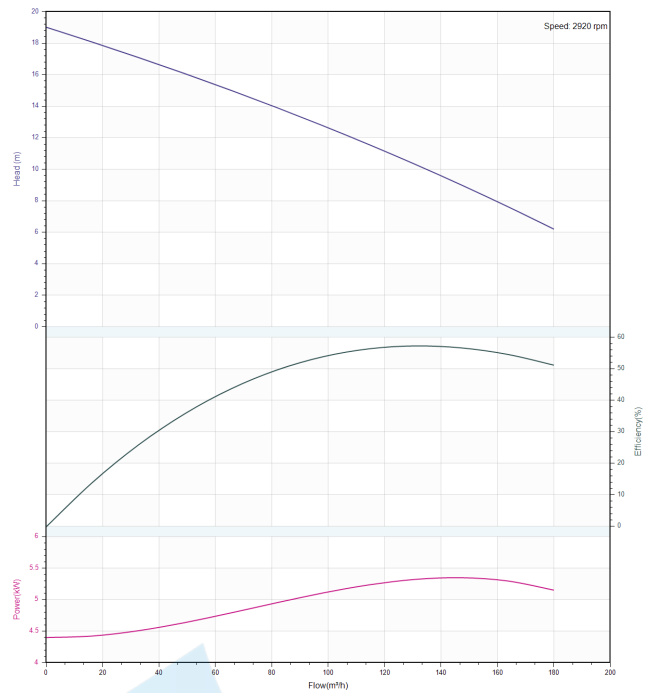

| | | | |
|--|--|--------------|--------------------------------------|
|  | Structure picture 100WQ/H130-10-5.5 | Manufacturer | CNP |
| | | Address | Yuhang District, Hangzhou, Zhejiang, |
| Project Name | | Contact | 86-571-88637351 |
| | | Date | 2022/03/08 |
| Item NO | | Client Name | DPA |
| | | Client Addr. | |
| | | Contacts | Alireza |
| | | Contact | |

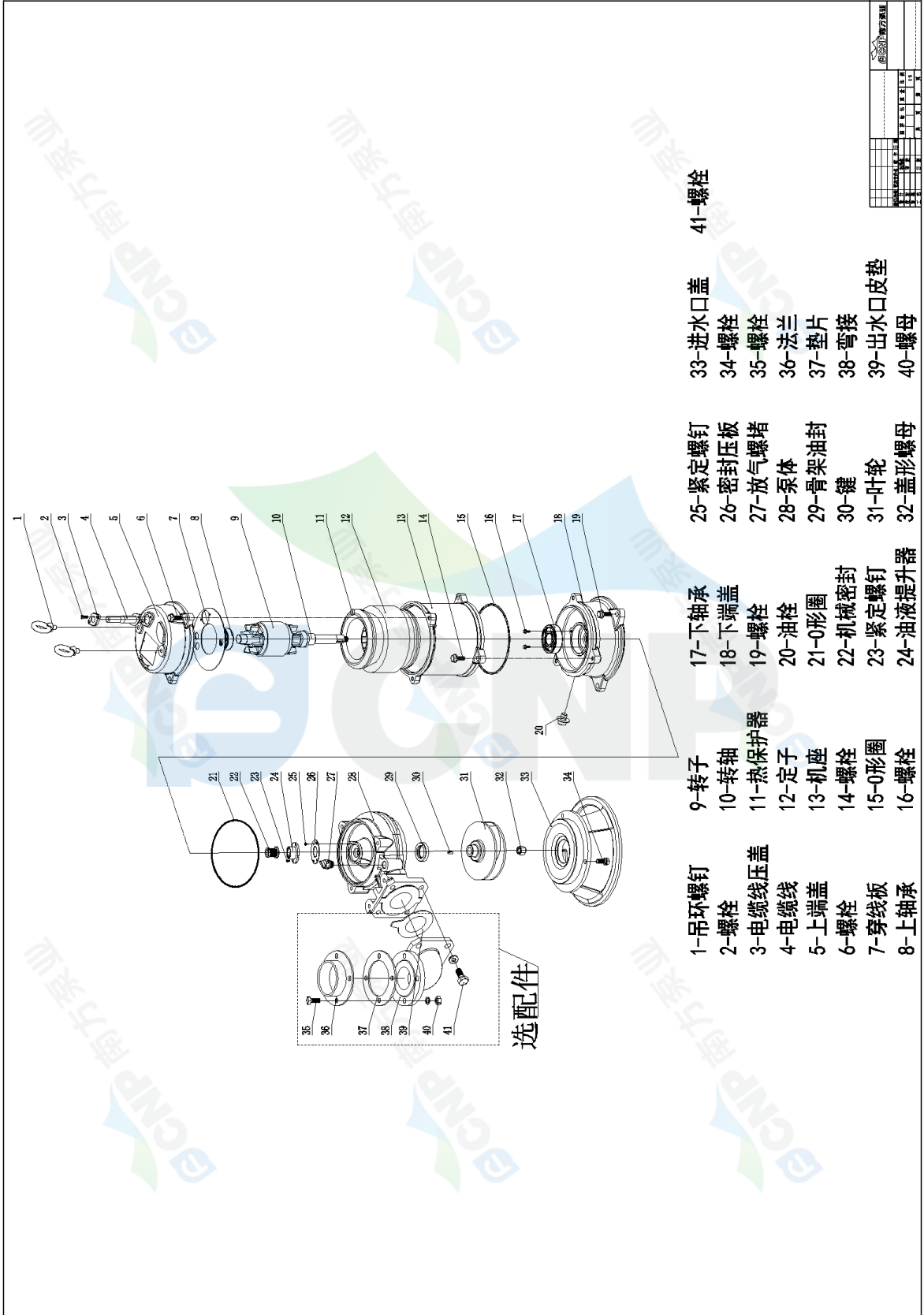

| | | | |
|--|--|--------------|--------------------------------------|
|  | Dimension Drawing 100WQ/H130-10-5.5 | Manufacturer | CNP |
| | | Address | Yuhang District, Hangzhou, Zhejiang, |
| Project Name | | Contact | 86-571-88637351 |
| | | Date | 2022/03/08 |
| Item NO | | Client Name | DPA |
| | | Client Addr. | |
| | | Contacts | Alireza |
| | | Contact | |

移动式安装尺寸图

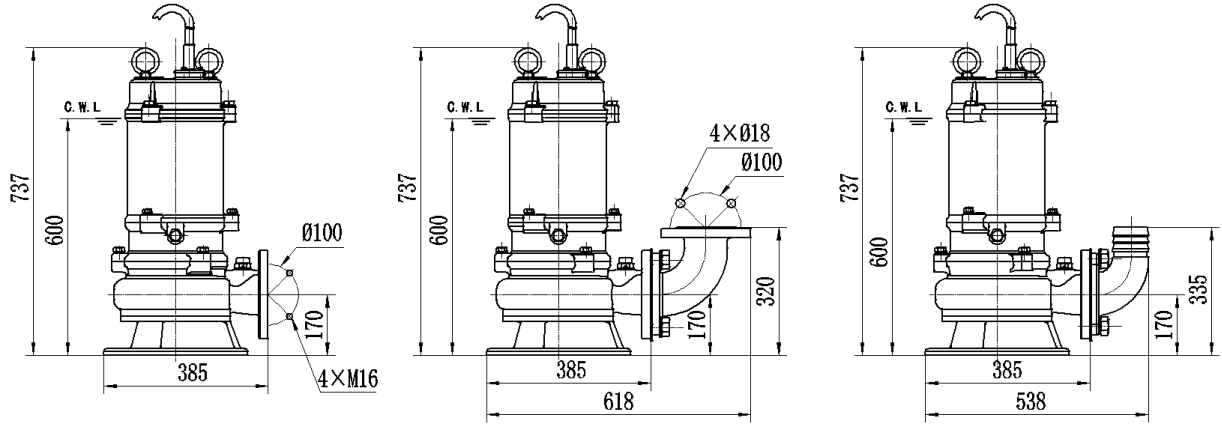

注：C.W.L为连续运行允许最低液位。

自动耦合式安装尺寸图

