	<b>Product Information</b> <b>80WQ40-17-4/QG(I)</b>	Manufacturer	CNP
		Address	Yuhang District, Hangzhou, Zhejiang,
<b>Project Name</b>		Contact	86-571-88637351
		Date	2022/03/09
<b>Item NO</b>		Client Name	DPA
		Client Addr.	
		Contacts	Alireza
		Contact	

Part NO.	80WQ40-17-4/QG(I)		
Product Picture	Note		
	<p>The sewage submersible pump is composed of two parts: the motor and the pump.</p> <p>The two are separated by an oil chamber and a mechanical seal assembly.</p> <p>Divided into fixed automatic coupling installation and mobile installation</p>		

### technology

Pump rotator speed	2840
Nameplate standards	CE

### Material

Impeller	HT200
Pump shaft	20cr13
Rubber code	P
Pump case	HT200

### Installation

Connection Code	F
Maximum Pressure/Temperatur	6bar/40
Flange Standard	DIN
Pressure Class	PN6

### Medium

Medium Temperature	40
Maximum diameter of partic	22
Maximum Environment Temper	40

### Structure dimension

Standard caliber	DN
Outlet Diameter	DN80

### Motor

Number of Motor Phase	Three Phase
Protection Class	IP68
Insulation Class	F
Motor Power	4
Power Frequency	50HZ
Rated Voltage (V)	380V
Rated Current (A)	7.7
Starting mode	direct boot

### Seal

Mechanical Seal	H-25
-----------------	------

### Others

Weight (kg)	48
-------------	----



### Performance Curve 80WQ40-17-4/QG(I)

Manufacturer	CNP
Address	Yuhang District, Hangzhou, Zhejiang,
Contact	86-571-88637351
Date	2022/03/09
Client Name	DPA
Client Addr.	
Contacts	Alireza
Contact	

Project Name

Item NO

The hydraulic performance curve have been tested with Clean Water at 20°C, density 1000kg/m<sup>3</sup>, and at 1bar atmospheric pressure. ISO99062012 Grade 3B

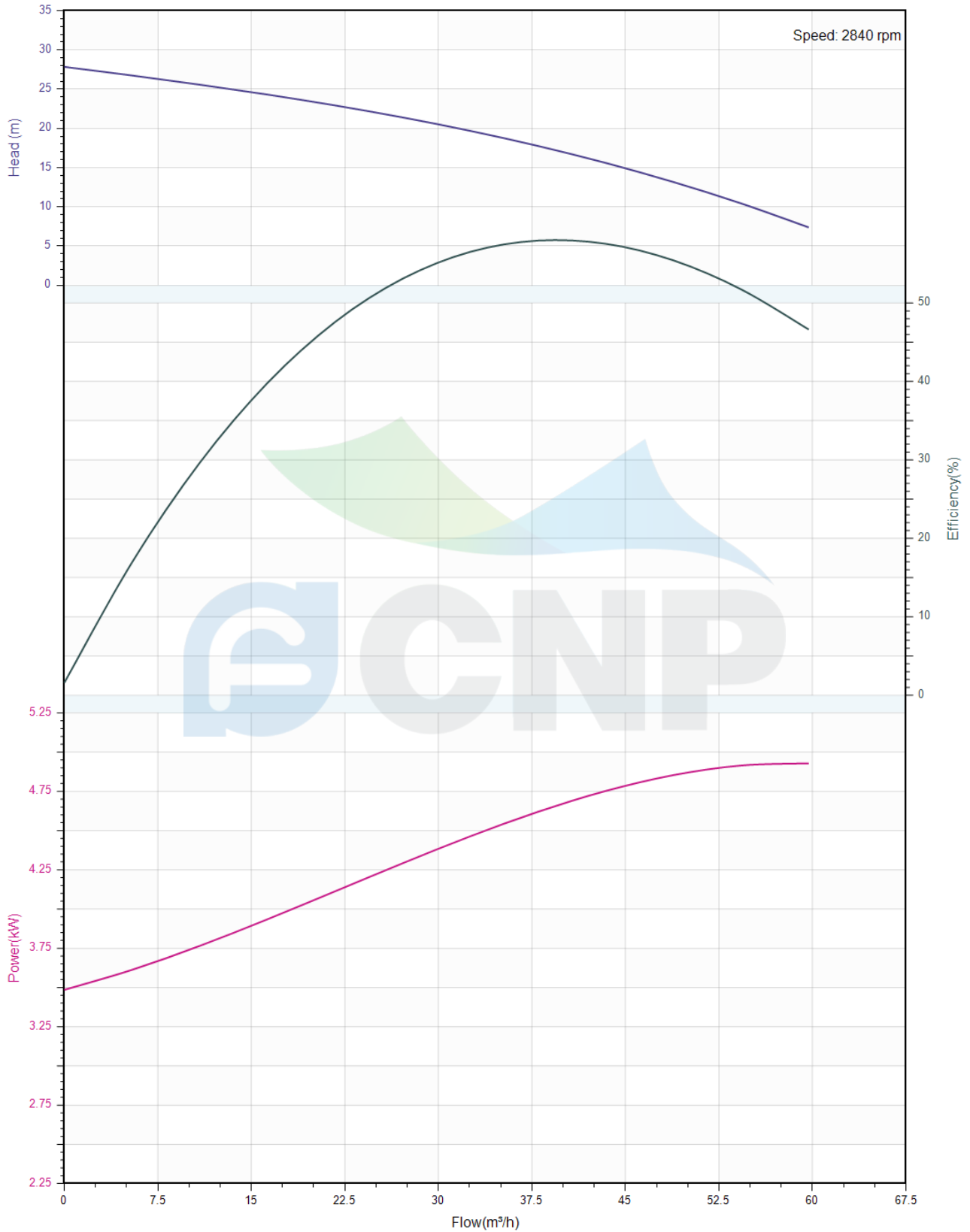



## Pump Technical Parameters 80WQ40-17-4/QG(I)

Manufacturer	CNP
Address	Yuhang District, Hangzhou, Zhejiang,
Contact	86-571-88637351
Date	2022/03/09
Client Name	DPA
Client Addr.	
Contacts	Alireza
Contact	

### Rated parameters

Pump model	80WQ40-17-4/QG(I)
Part NO.	80WQ40-17-4/QG(I)
Rated flow (m <sup>3</sup> /h)	40
Rated head (m)	17
Rated efficiency (%)	60
Power (kW)	3.39
Speed (rpm)	2840

### Medium

Pumped medium	Clean Water
Working temperature (°C)	20
Medium density (kg/m <sup>3</sup> )	1000
Viscosity (mm <sup>2</sup> /s)	1

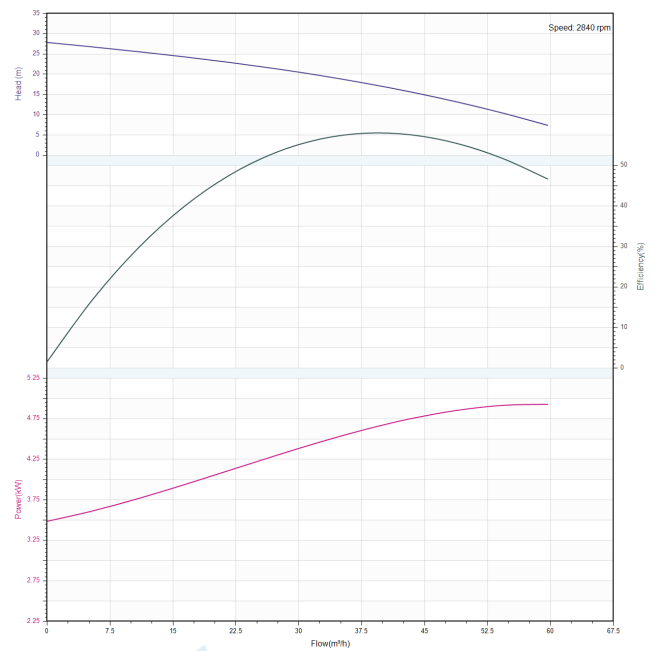

	<b>Structure picture</b> <b>80WQ40-17-4/QG(I)</b>	Manufacturer	CNP
		Address	Yuhang District, Hangzhou, Zhejiang,
Project Name		Contact	86-571-88637351
		Date	2022/03/09
Item NO		Client Name	DPA
		Client Addr.	
		Contacts	Alireza
		Contact	

**CNP Nanfang Zhongjin Environment Co., Ltd.**

	<b>SECTIONAL DRAWING</b>	No.	No.
TYPE	submersible sewage pump	MODEL	WQ-1.5/2.2/3.0/4.0kW

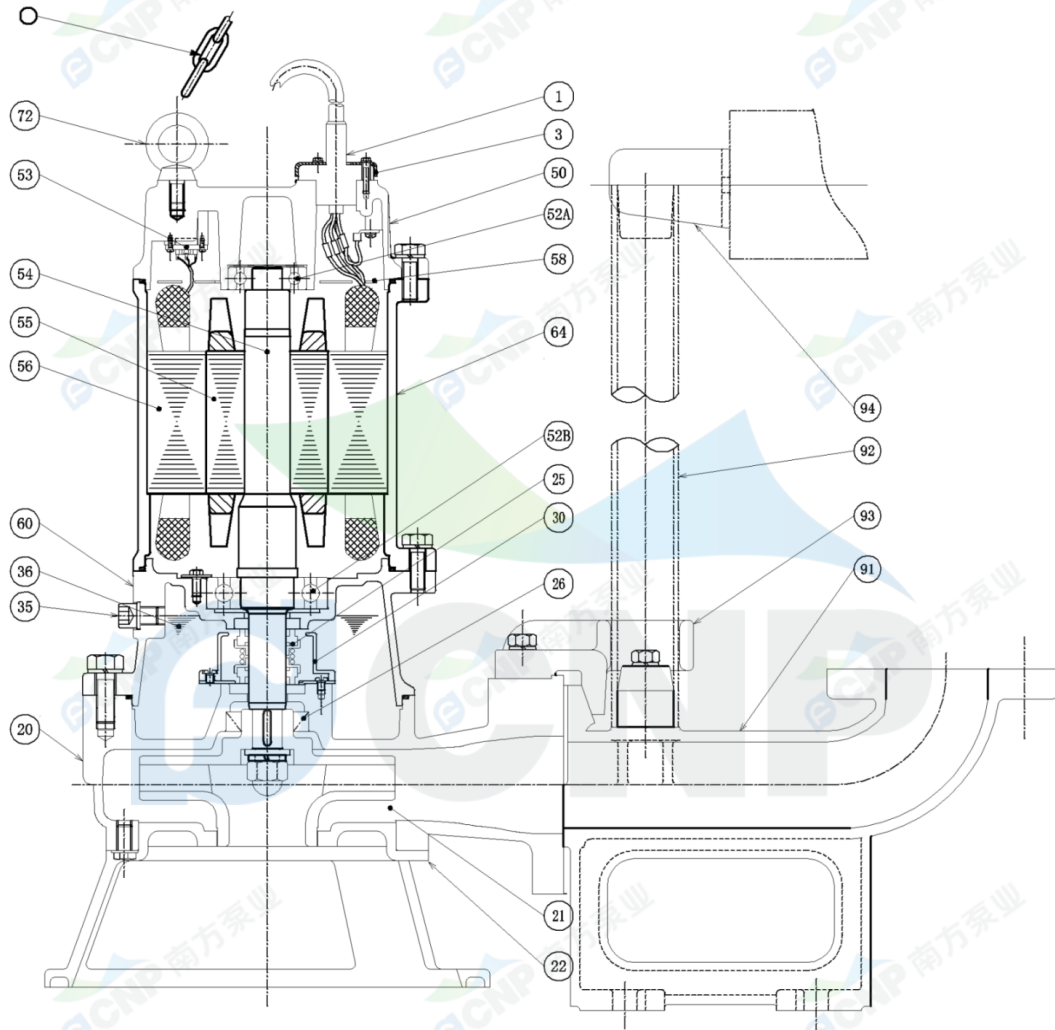

order specifications							
No.	names of parts	number	material	No.	names of parts	number	material
1	cable	1	YZW	22	water inlet cover	1	HT200
3	cable cover	1	SUS304	20	casing	1	HT200
50	top cover	1	HT200	35	oil filler plug	1	SUS304
52A	upper bearing	1		36	machine oil 32#		
58	cable transit board	1		60	lower cover	1	HT200
64	base	1	HT200	56	stator	1	
52B	lower bearing	1		55	rotor	1	
25	mechanical seal	1	Carbon/SIC	54	shaft	1	
30	oil lift	1		53	thermal protector	1	
26	framework oil seal	1	NBRI-2	72	eye bolt	2	45#(forging galvanized)
93	guide hook	1	HT200	91	water outlet base	1	HT200
21	impeller	1	HT200	94	guiding	1	HT200
510	lift chain	1	SUS304	92	pipe	1	SUS304(unaffiliated)

Nanfang Zhongjin Environment CO.,LTD.

unit : mm



# Installation picture

## 80WQ40-17-4/QG(I)

Manufacturer	CNP
Address	Yuhang District, Hangzhou, Zhejiang,
Contact	86-571-88637351
Date	2022/03/09
Client Name	DPA
Client Addr.	
Contacts	Alireza
Contact	

Project Name

Item NO

**CNP Nanfang Zhongjin Environment Co., Ltd.**

DIMENSION DRAWING		No.													
TYPE submersible sewage pump		MODEL	80WQ40-17-4/QG												
MODEL	A	A1	A2	A3	A4	A5	B	B1	D	DI	WI	W2	H	Body weight	
WQ40-17-4/QG	80	449	510	123	190	284.5	302	311	291	258	128	463.5	193.5	605.5	45kg

diameter	80	4.5kg	7.5kg
elbow weight			
bend weight			

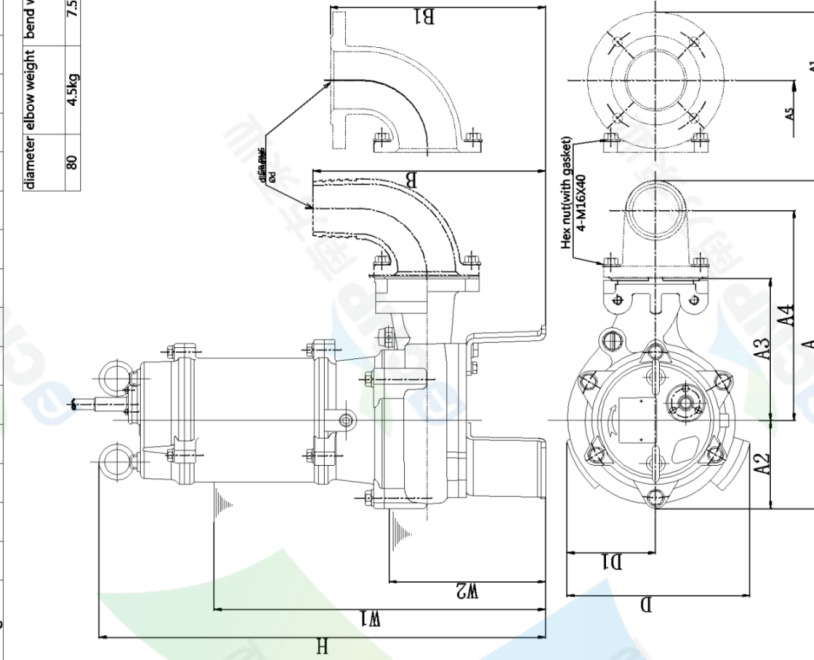

C.W.L.: minimum water level under continuous operation  
L.W.L.: minimum water level under possible operation

unit : mm

Nanfang Zhongjin Environment CO.,LTD.

**CNP Nanfang Zhongjin Environment Co., Ltd.**

DIMENSION DRAWING		No.												
TYPE submersible sewage pump		MODEL	80WQ40-17-4/QG											
MODEL	A	A1	A2	A3	A4	A5	B	B1	D	DI	WI	W2	H	Body weight
WQ40-17-4/QG	80	449	510	123	190	284.5	302	311	291	258	128	463.5	193.5	605.5

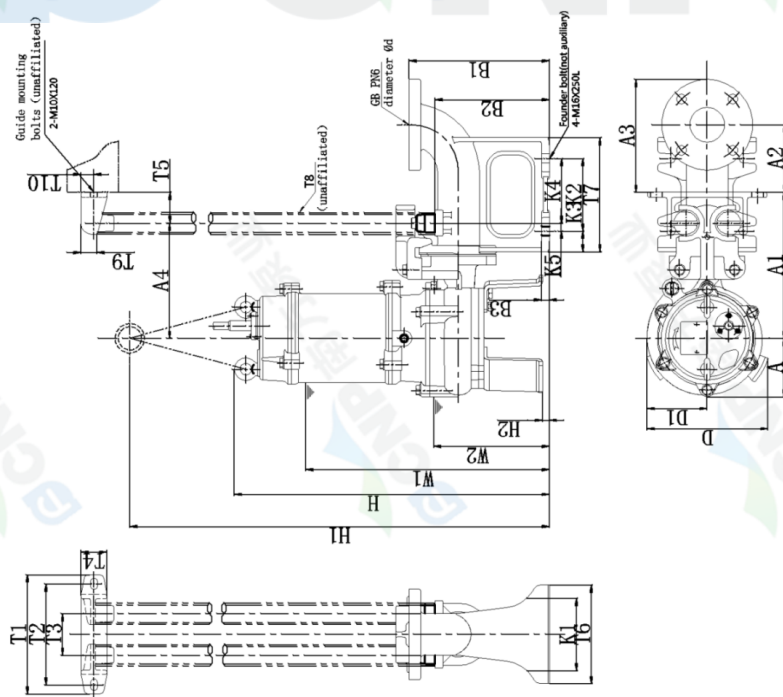

C.W.L.: minimum water level under continuous operation  
L.W.L.: minimum water level under possible operation

unit : mm

Nanfang Zhongjin Environment CO.,LTD.