



| | | | |
|----------------------------------------------------------------------------------|--------------------------------------------------------|--------------|----------------------------|
|  | Product information 65WQ30-54-11JY(I) | Manufacturer | CNP |
| | | Address | Yuhang District, Hangzhou, |
| Project Name | | Contact | 86-571-88637351 |
| | | Date | 2022/03/09 |
| Station Number | | Client Name | DPA |
| | | Client Addr. | |
| | | Contacts | Alireza |
| | | Contact | |

| | |
|-------------|----------------|
| Product No. | 65WQ30-54-11JY |
|-------------|----------------|

| | |
|-----------------------------------------------------------------------------------|----------------------------------------------------------------------------|
| Product picture(Note:the picture may not be the same as the | Series description |
|  | Single channel or double channel impeller.Auto-coupling system on request. |

| | |
|-------------------------------|-------------|
| Performance Data | |
| Rated flow(m ³ /h) | 30 |
| Rated head(m) | 54 |
| Efficiency(%) | 52.7 |
| Rated power(kW)(kW) | 8.38 |
| NPSHr(m) | 2 |
| Rate Speed(rpm) | 2930 |
| technology | |
| Pump rotator speed | 2930 |
| Nameplate standards | CE |
| Material | |
| Impeller | QT650 |
| Pump shaft | 20cr13 |
| Rubber code | P |
| Pump case | QT650 |
| Installation | |
| Connection Code | F |
| Maximum Pressure/Temperatu | 6bar/40 |
| Flange Standard | DIN |
| Pressure Class | PN6 |
| Medium | |
| Medium Temperature | 40 |
| Maximum diameter of partic | 22 |
| Maximum Environment Temper | 40 |
| Structure dimension | |
| Standard | DN |
| Outlet size | DN65 |
| Motor | |
| Number of Motor Phase | Three Phase |
| Protection Class | IP68 |
| Insulation Class | F |
| Motor Power | 11 |
| Power Frequency | 50HZ |
| Rated Voltage (V) | 380V |

| | | | |
|----------------------------------------------------------------------------------|--------------------------------------------------------|--------------|----------------------------|
|  | Product information 65WQ30-54-11JY(I) | Manufacturer | CNP |
| | | Address | Yuhang District, Hangzhou, |
| | | Contact | 86-571-88637351 |
| | | Date | 2022/03/09 |
| Project Name | | Client Name | DPA |
| | | Client Addr. | |
| Station Number | | Contacts | Alireza |
| | | Contact | |

Rated Current (A) 21.7
Starting mode direct boot

Seal

Mechanical Seal H-30

Others

Weight (kg) 98





Performance Curve 65WQ30-54-11JY(I)

| | |
|--------------|----------------------------|
| Manufacturer | CNP |
| Address | Yuhang District, Hangzhou, |
| Contact | 86-571-88637351 |
| Date | 2022/03/09 |
| Client Name | DPA |
| Client Addr. | |
| Contacts | Alireza |
| Contact | |

Project Name

Station Number

Medium Name Clear Water , Temperature 20°C, Density 1000kg/m³, Viscosity 1mm²/s, (ISO99062012 Grande 3B)

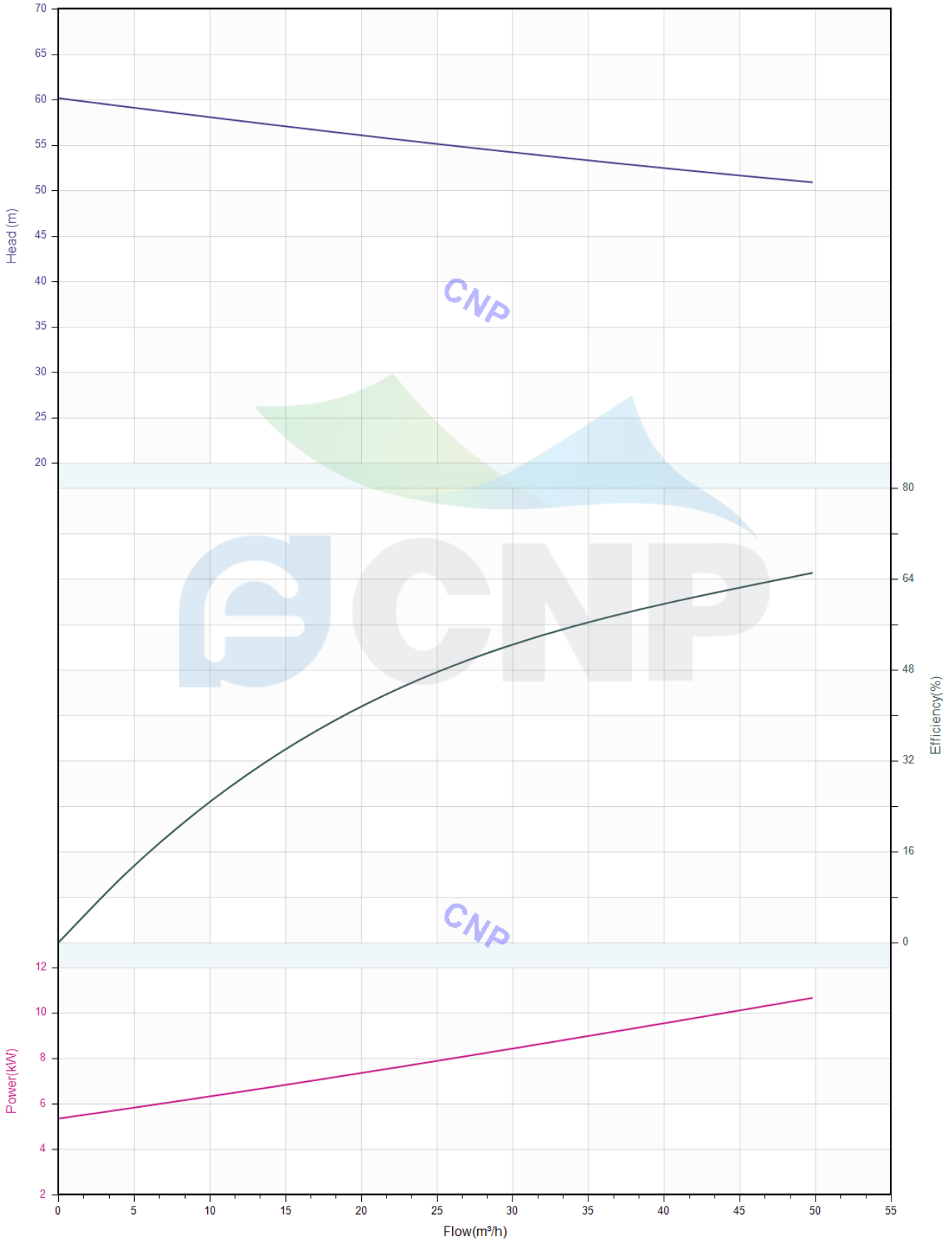



Pump technical parameters 65WQ30-54-11JY(I)

| | |
|--------------|----------------------------|
| Manufacturer | CNP |
| Address | Yuhang District, Hangzhou, |
| Contact | 86-571-88637351 |
| Date | 2022/03/09 |
| Client Name | DPA |
| Client Addr. | |
| Contacts | Alireza |
| Contact | |

Project Name

Station Number

Rated parameters

| | |
|-------------------------------|-------------------|
| Pump model | 65WQ30-54-11JY(I) |
| Product No. | 65WQ30-54-11JY |
| Rated flow(m ³ /h) | 30 |
| Rated pressure(m) | 54 |
| Rated efficiency(%) | 52.7 |
| Power(kW) | 8.38 |
| NPSHr(m) | 2 |
| Speed(rpm) | 2930 |

Medium

| | |
|------------------------------------|-------------|
| Medium Name | Clear Water |
| Working temperature(°C) | 20 |
| Medium density(kg/m ³) | 1000 |
| Viscosity(mm ² /s) | 1 |

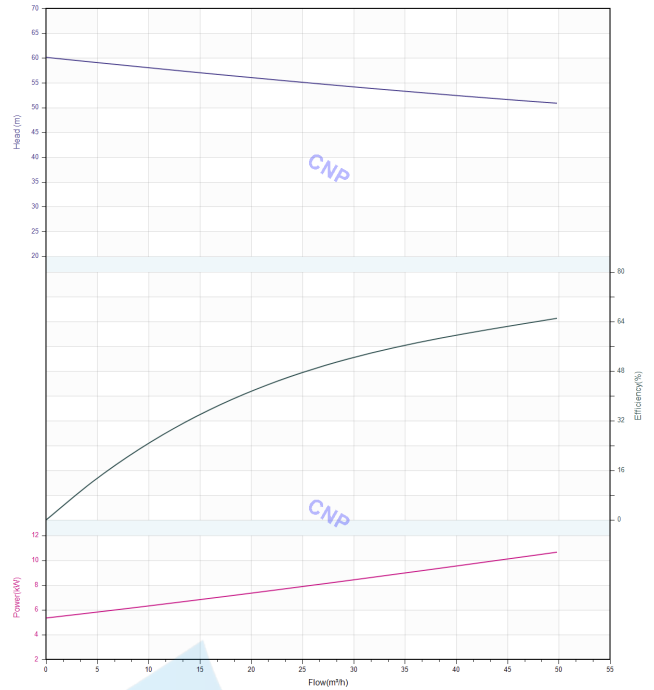

| | | | |
|----------------------------------------------------------------------------------|------------------------------------------------------|--------------|----------------------------|
|  | Structure picture 65WQ30-54-11JY(I) | Manufacturer | CNP |
| | | Address | Yuhang District, Hangzhou, |
| Project Name | | Contact | 86-571-88637351 |
| | | Date | 2022/03/09 |
| Station Number | | Client Name | DPA |
| | | Client Addr. | |
| | | Contacts | Alireza |
| | | Contact | |

CNP Nanfang Zhongjin Environment Co., Ltd.

| | | | |
|------|-------------------------|-------|------------|
| | SECTIONAL DRAWING | No. | No. |
| TYPE | submersible sewage pump | MODEL | WQ-11/15kW |

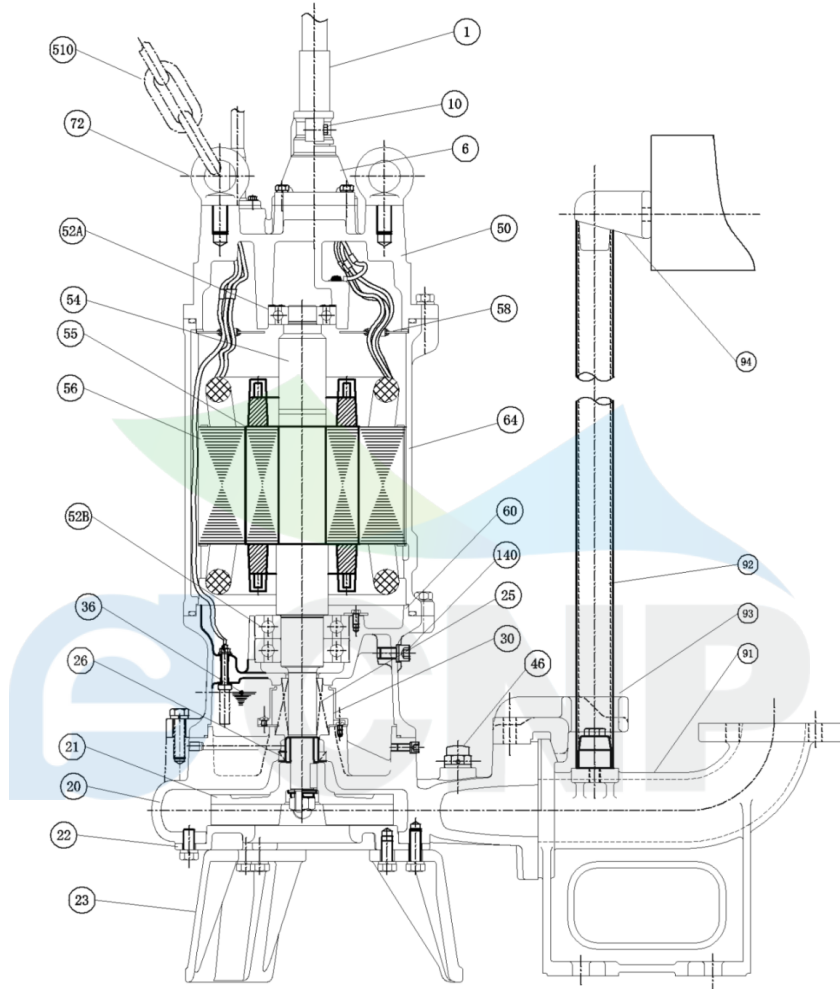

| | |
|----------------------|--|
| order specifications | |
| | |

| No. | names of parts | number | material | No. | names of parts | number | material |
|-----|---------------------|--------|----------------------|-----|--------------------|--------|-------------------------|
| 1 | cable | 1 | YZW | 20 | casing | 1 | HT200 |
| 6 | cable sleeve | 1 | HT200 | 21 | impeller | 1 | HT200 |
| 50 | top cover | 1 | HT200 | 26 | framework oil seal | 1 | NBR-2 |
| 58 | cable transit board | 1 | Q235 | 140 | oil filler plug | 2 | SUS304 |
| 64 | base | 1 | HT200 | 36 | machine oil 32# | | |
| 25 | mechanical seal | 1 | Carbon/SIC | 52B | lower bearing | 2 | |
| 60 | lower cover | 1 | HT200 | 56 | stator | 1 | |
| 30 | oil lift | 1 | | 55 | rotor | 1 | |
| 46 | Air release bolt | 1 | | 54 | shaft | 1 | |
| 94 | guiding | 1 | HT200 | 52A | upper bearing | 1 | |
| 92 | pipe | 1 | SUS304(unaffiliated) | 72 | eye bolt | 2 | SUS304 |
| 93 | guide hook | 1 | HT200 | 510 | lift chain | 1 | 45#(forging galvanized) |
| 91 | water outlet base | 1 | HT200 | 23 | foot bracket | 3 | HT200 |
| 22 | water inlet cover | 1 | HT200 | 10 | Cable lockblock | 2 | HT200 |

Nanfang Zhongjin Environment CO.,LTD.

unit : mm



Installation picture 65WQ30-54-11JY(I)

| | |
|--------------|----------------------------|
| Manufacturer | CNP |
| Address | Yuhang District, Hangzhou, |
| Contact | 86-571-88637351 |
| Date | 2022/03/09 |
| Client Name | DPA |
| Client Addr. | |
| Contacts | Alireza |
| Contact | |

Project Name

Station Number

CNP 中金环境

| 安装外形尺寸 DIMENSION DRAWING | | No. | | | | | | | | | | | | | | | | | | | | | | | | | | | | | | | | | | | | | | | | | | | | | | | | | | | | | | | | | | | | | | | | | | | | | | | | | | | | | | | | | | | | | | | | | | | | | | | | | | | | | | | | | | | | | | | | | | | | | | | | | | | | | | | | | | | | | | | | | | | | | | | | | | | | | | | | | | | | | | | | | | | | | | | | | | | | | | | | | | | | | | | | | | | | | | | | | | | | | | | | | | | | | | | | | | | | | | | | | | | | | | | | | | | | | | | | | | | | | | | | | | | | | | | | | | | | | | | | | | | | | | | | | | | | | | | | | | | | | | | | | | | | | | | | | | | | | | | | | | | | | | | | | | | | | | | | | | | | | | | | | | | | | | | | | | | | | | | | | | | | | | | | | | | | | | | | | | | | | | | | | | | | | | | | | | | | | | | | | | | | | | | | | | | | | | | | | | | | | | | | | | | | | | | | | | | | | | | | | | | | | | | | | | | | | | | | | | | | | | | | | | | | | | | | | | | | | | | | | | | | | | | | | | | | | | | | | | | | | | | | | | | | | | | | | | | | | | | | | | | | | | | | | | | | | | | | | | | | | | | | | | | | | | | | | | | | | | | | | | | | | | | | | | | | | | | | | | | | | | | | | | | | | | | | | | | | | | | | | | | | | | | | | | | | | | | | | | | | | | | | | | | | | | | | | | | | | | | | | | | | | | | | | | | | | | | | | | | | | | | | | | | | | | | | | | | | | | | | | | | | | | | | | | | | | | | | | | | | | | | | | | | | | | | | | | | | | | | | | | | | | | | | | | | | | | | | | | | | | | | | | | | | | | | | | | | | | | | | | | | | | | | | | | | | | | | | | | | | | | | | | | | | | | | | | | | | | | | | | | | | | | | | | | | | | | | | | | | | | | | | | | | | | | | | | | | | | | | | | | | | | | | | | | | | | | | | | | | | | | | | | | | | | | | | | | | | | | | | | | | | | | | | | | | | | | | | | | | | | | | | | | | | | | | | | | | | | | | | | | | | | | | | | | | | | | | | | | | | | | | | | | | | | | | | | | | | | | | | | | | | | | | | | | | | | | | | | | | | | | | | | | | | | | | | | | | | | | | | | | | | | | | | | | | | | | | | | | | | | | | | | | | | | | | | | | | | | | | | | | | | | | | | | | | | | | | | | | | | | | | | | | | | | | | | | | | | | | | | | | | | | | | | | | | | | | | | | | | | | | | | | | | | | | | | | | | | | | | | | | | | | | | | | | | | | | | | | | | | | | | | | | | | | | | | | | | | | | | | | | | | | | | | | | | | | | | | | | | | | | | | | | | | | | | | | | | | | | | | | | | | | | | | | | | | | | | | | | | | | | | | | | | | | | | | | | | | | | | | | | | | | | | | | | | | | | | | | | | | | | | | | | | | | | | | | | | | | | | | | | | | | | | | | | | | | | | | | | | | | | | | | | | | | | | | | | | | | | | | | | | | | | | | | | | | | | | | | | | | | | | | | | | | | | | | | | | | | | | | | | | | | | | | | | | | | | | | | | | | | | | | | | | | | | | | | | | | | | | | | | | | | | | | | | | | | | | | | | | | | | | | | | | | | | | | | | | | | | | | |
|--------------------------|-------------|----------------|-----|-----|-----|-----|-----|-----|-----|------|-----|----------|------|-----|-----|-----|-----|-----|-----|-----|-----|-----|-----|-----|-----|-----|-----|-----|-----|-----|-----|-----|-----|-----|-----|-----|-----|-----|-----|-----|-----|-----|-----|-----|-----|-----|-----|-----|-----|-----|-----|-----|-----|-----|-----|-----|-----|-----|-----|-----|-----|-----|-----|-----|-----|-----|-----|-----|-----|-----|-----|-----|-----|-----|-----|-----|-----|-----|-----|-----|-----|-----|-----|-----|-----|-----|-----|-----|-----|-----|-----|-----|-----|-----|-----|-----|-----|-----|-----|-----|------|------|------|------|------|------|------|------|------|------|------|------|------|------|------|------|------|------|------|------|------|------|------|------|------|------|------|------|------|------|------|------|------|------|------|------|------|------|------|------|------|------|------|------|------|------|------|------|------|------|------|------|------|------|------|------|------|------|------|------|------|------|------|------|------|------|------|------|------|------|------|------|------|------|------|------|------|------|------|------|------|------|------|------|------|------|------|------|------|------|------|------|------|------|------|------|------|------|------|------|------|------|------|------|------|------|------|------|------|------|------|------|------|------|------|------|------|------|------|------|------|------|------|------|------|------|------|------|------|------|------|------|------|------|------|------|------|------|------|------|------|------|------|------|------|------|------|------|------|------|------|------|------|------|------|------|------|------|------|------|------|------|------|------|------|------|------|------|------|------|------|------|------|------|------|------|------|------|------|------|------|------|------|------|------|------|------|------|------|------|------|------|------|------|------|------|------|------|------|------|------|------|------|------|------|------|------|------|------|------|------|------|------|------|------|------|------|------|------|------|------|------|------|------|------|------|------|------|------|------|------|------|------|------|------|------|------|------|------|------|------|------|------|------|------|------|------|------|------|------|------|------|------|------|------|------|------|------|------|------|------|------|------|------|------|------|------|------|------|------|------|------|------|------|------|------|------|------|------|------|------|------|------|------|------|------|------|------|------|------|------|------|------|------|------|------|------|------|------|------|------|------|------|------|------|------|------|------|------|------|------|------|------|------|------|------|------|------|------|------|------|------|------|------|------|------|------|------|------|------|------|------|------|------|------|------|------|------|------|------|------|------|------|------|------|------|------|------|------|------|------|------|------|------|------|------|------|------|------|------|------|------|------|------|------|------|------|------|------|------|------|------|------|------|------|------|------|------|------|------|------|------|------|------|------|------|------|------|------|------|------|------|------|------|------|------|------|------|------|------|------|------|------|------|------|------|------|------|------|------|------|------|------|------|------|------|------|------|------|------|------|------|------|------|------|------|------|------|------|------|------|------|------|------|------|------|------|------|------|------|------|------|------|------|------|------|------|------|------|------|------|------|------|------|------|------|------|------|------|------|------|------|------|------|------|------|------|------|------|------|------|------|------|------|------|------|------|------|------|------|------|------|------|------|------|------|------|------|------|------|------|------|------|------|------|------|------|------|------|------|------|------|------|------|------|------|------|------|------|------|------|------|------|------|------|------|------|------|------|------|------|------|------|------|------|------|------|------|------|------|------|------|------|------|------|------|------|------|------|------|------|------|------|------|------|------|------|------|------|------|------|------|------|------|------|------|------|------|------|------|------|------|------|------|------|------|------|------|------|------|------|------|------|------|------|------|------|------|------|------|------|------|------|------|------|------|------|------|------|------|------|------|------|------|------|------|------|------|------|------|------|------|------|------|------|------|------|------|------|------|------|------|------|------|------|------|------|------|------|------|------|------|------|------|------|------|------|------|------|------|------|------|------|------|------|------|------|------|------|------|------|------|------|------|------|------|------|------|------|------|------|------|------|------|------|------|------|------|------|------|------|------|------|------|------|------|------|------|------|------|------|------|------|------|------|------|------|------|------|------|------|------|------|------|------|------|------|------|------|------|------|------|------|------|------|------|------|------|------|------|------|------|------|------|------|------|------|------|------|------|------|------|------|------|------|------|------|------|------|------|------|------|------|------|------|------|------|------|------|------|------|------|------|------|------|------|------|------|------|------|------|------|------|------|------|------|------|------|------|------|------|------|------|------|------|------|------|------|------|------|------|------|------|------|------|------|------|------|------|------|------|------|------|------|------|------|------|------|------|------|------|------|------|------|------|------|------|------|------|------|------|------|------|------|------|------|------|------|------|------|------|------|------|------|------|------|------|------|------|------|------|------|------|------|------|------|------|------|------|------|------|------|------|------|------|------|------|------|------|------|------|------|------|------|------|------|------|------|------|------|------|------|------|------|------|------|------|------|------|------|------|------|------|------|------|------|------|------|------|------|------|------|------|------|------|------|------|------|------|------|------|------|------|------|------|------|------|------|------|------|------|------|------|------|------|------|------|------|------|------|------|------|------|------|------|------|------|------|------|------|-------|-------|-------|-------|-------|-------|-------|-------|-------|-------|-------|-------|-------|-------|-------|-------|-------|-------|-------|-------|-------|-------|-------|-------|-------|-------|-------|-------|-------|-------|-------|-------|-------|-------|-------|-------|-------|-------|-------|-------|-------|-------|-------|-------|-------|-------|-------|-------|-------|-------|-------|-------|-------|-------|-------|-------|-------|-------|-------|-------|-------|-------|-------|-------|-------|-------|-------|-------|-------|-------|-------|-------|-------|-------|-------|-------|-------|-------|-------|-------|-------|-------|-------|-------|-------|-------|-------|-------|-------|-------|-------|-------|-------|-------|-------|-------|-------|-------|-------|-------|-------|-------|-------|-------|-------|-------|-------|-------|-------|-------|-------|-------|-------|-------|-------|-------|-------|-------|-------|-------|-------|-------|-------|-------|-------|-------|-------|-------|-------|-------|-------|-------|-------|-------|-------|-------|-------|-------|-------|-------|-------|-------|-------|-------|-------|-------|-------|-------|-------|-------|-------|-------|-------|-------|-------|-------|-------|-------|-------|-------|-------|-------|-------|-------|-------|-------|-------|-------|-------|-------|-------|-------|-------|-------|-------|-------|-------|-------|-------|-------|-------|-------|-------|-------|-------|-------|-------|-------|-------|-------|-------|-------|-------|-------|-------|-------|-------|-------|-------|-------|-------|-------|-------|-------|-------|-------|-------|-------|-------|-------|-------|-------|-------|-------|-------|-------|-------|-------|-------|-------|-------|-------|-------|-------|-------|-------|-------|-------|-------|-------|-------|-------|-------|-------|-------|-------|-------|-------|-------|-------|-------|-------|-------|-------|-------|-------|-------|-------|-------|-------|-------|-------|-------|-------|-------|-------|-------|-------|-------|-------|-------|-------|-------|-------|-------|-------|-------|-------|-------|-------|-------|-------|-------|-------|-------|-------|-------|-------|-------|-------|-------|-------|-------|-------|-------|-------|-------|-------|-------|-------|-------|-------|-------|-------|-------|-------|-------|-------|-------|-------|-------|-------|-------|-------|-------|-------|-------|-------|-------|-------|-------|-------|-------|-------|-------|-------|-------|-------|-------|-------|-------|-------|-------|-------|-------|-------|-------|-------|-------|-------|-------|-------|-------|-------|-------|-------|-------|-------|-------|-------|-------|-------|-------|-------|-------|-------|-------|-------|-------|-------|-------|-------|-------|-------|-------|-------|-------|-------|-------|-------|-------|-------|-------|-------|-------|-------|-------|-------|-------|-------|-------|-------|-------|-------|-------|-------|-------|-------|-------|-------|-------|-------|-------|-------|-------|-------|-------|-------|-------|-------|-------|-------|-------|-------|-------|-------|-------|-------|-------|-------|-------|-------|-------|-------|-------|-------|-------|-------|-------|-------|-------|-------|-------|-------|-------|-------|-------|---|
| TYPE 名称 | MODEL 型号 | 65WQ30-54-11JY | | | | | | | | | | | | | | | | | | | | | | | | | | | | | | | | | | | | | | | | | | | | | | | | | | | | | | | | | | | | | | | | | | | | | | | | | | | | | | | | | | | | | | | | | | | | | | | | | | | | | | | | | | | | | | | | | | | | | | | | | | | | | | | | | | | | | | | | | | | | | | | | | | | | | | | | | | | | | | | | | | | | | | | | | | | | | | | | | | | | | | | | | | | | | | | | | | | | | | | | | | | | | | | | | | | | | | | | | | | | | | | | | | | | | | | | | | | | | | | | | | | | | | | | | | | | | | | | | | | | | | | | | | | | | | | | | | | | | | | | | | | | | | | | | | | | | | | | | | | | | | | | | | | | | | | | | | | | | | | | | | | | | | | | | | | | | | | | | | | | | | | | | | | | | | | | | | | | | | | | | | | | | | | | | | | | | | | | | | | | | | | | | | | | | | | | | | | | | | | | | | | | | | | | | | | | | | | | | | | | | | | | | | | | | | | | | | | | | | | | | | | | | | | | | | | | | | | | | | | | | | | | | | | | | | | | | | | | | | | | | | | | | | | | | | | | | | | | | | | | | | | | | | | | | | | | | | | | | | | | | | | | | | | | | | | | | | | | | | | | | | | | | | | | | | | | | | | | | | | | | | | | | | | | | | | | | | | | | | | | | | | | | | | | | | | | | | | | | | | | | | | | | | | | | | | | | | | | | | | | | | | | | | | | | | | | | | | | | | | | | | | | | | | | | | | | | | | | | | | | | | | | | | | | | | | | | | | | | | | | | | | | | | | | | | | | | | | | | | | | | | | | | | | | | | | | | | | | | | | | | | | | | | | | | | | | | | | | | | | | | | | | | | | | | | | | | | | | | | | | | | | | | | | | | | | | | | | | | | | | | | | | | | | | | | | | | | | | | | | | | | | | | | | | | | | | | | | | | | | | | | | | | | | | | | | | | | | | | | | | | | | | | | | | | | | | | | | | | | | | | | | | | | | | | | | | | | | | | | | | | | | | | | | | | | | | | | | | | | | | | | | | | | | | | | | | | | | | | | | | | | | | | | | | | | | | | | | | | | | | | | | | | | | | | | | | | | | | | | | | | | | | | | | | | | | | | | | | | | | | | | | | | | | | | | | | | | | | | | | | | | | | | | | | | | | | | | | | | | | | | | | | | | | | | | | | | | | | | | | | | | | | | | | | | | | | | | | | | | | | | | | | | | | | | | | | | | | | | | | | | | | | | | | | | | | | | | | | | | | | | | | | | | | | | | | | | | | | | | | | | | | | | | | | | | | | | | | | | | | | | | | | | | | | | | | | | | | | | | | | | | | | | | | | | | | | | | | | | | | | | | | | | | | | | | | | | | | | | | | | | | | | | | | | | | | | | | | | | | | | | | | | | | | | | | | | | | | | | | | | | | | | | | | | | | | | | | | | | | | | | | | | | | | | | | | | | | | | | | | | | | | | | | | | | | | | | | | | | | | | | | | | | | | | | | | | | | | | | | | | | | | | | | | | | | | | | | | | | | | | | | | | | | | | | | | | | | | | | | | | | | | | | | | | | | | | | | | | | | | | | | | | | | | | | | | | | | | | | | | | | | | | | | | | | | | | | | | | |
| 型号 | A | A1 | A2 | A3 | A4 | D | D1 | D2 | H | H1 | H2 | 重量 kg | | | | | | | | | | | | | | | | | | | | | | | | | | | | | | | | | | | | | | | | | | | | | | | | | | | | | | | | | | | | | | | | | | | | | | | | | | | | | | | | | | | | | | | | | | | | | | | | | | | | | | | | | | | | | | | | | | | | | | | | | | | | | | | | | | | | | | | | | | | | | | | | | | | | | | | | | | | | | | | | | | | | | | | | | | | | | | | | | | | | | | | | | | | | | | | | | | | | | | | | | | | | | | | | | | | | | | | | | | | | | | | | | | | | | | | | | | | | | | | | | | | | | | | | | | | | | | | | | | | | | | | | | | | | | | | | | | | | | | | | | | | | | | | | | | | | | | | | | | | | | | | | | | | | | | | | | | | | | | | | | | | | | | | | | | | | | | | | | | | | | | | | | | | | | | | | | | | | | | | | | | | | | | | | | | | | | | | | | | | | | | | | | | | | | | | | | | | | | | | | | | | | | | | | | | | | | | | | | | | | | | | | | | | | | | | | | | | | | | | | | | | | | | | | | | | | | | | | | | | | | | | | | | | | | | | | | | | | | | | | | | | | | | | | | | | | | | | | | | | | | | | | | | | | | | | | | | | | | | | | | | | | | | | | | | | | | | | | | | | | | | | | | | | | | | | | | | | | | | | | | | | | | | | | | | | | | | | | | | | | | | | | | | | | | | | | | | | | | | | | | | | | | | | | | | | | | | | | | | | | | | | | | | | | | | | | | | | | | | | | | | | | | | | | | | | | | | | | | | | | | | | | | | | | | | | | | | | | | | | | | | | | | | | | | | | | | | | | | | | | | | | | | | | | | | | | | | | | | | | | | | | | | | | | | | | | | | | | | | | | | | | | | | | | | | | | | | | | | | | | | | | | | | | | | | | | | | | | | | | | | | | | | | | | | | | | | | | | | | | | | | | | | | | | | | | | | | | | | | | | | | | | | | | | | | | | | | | | | | | | | | | | | | | | | | | | | | | | | | | | | | | | | | | | | | | | | | | | | | | | | | | | | | | | | | | | | | | | | | | | | | | | | | | | | | | | | | | | | | | | | | | | | | | | | | | | | | | | | | | | | | | | | | | | | | | | | | | | | | | | | | | | | | | | | | | | | | | | | | | | | | | | | | | | | | | | | | | | | | | | | | | | | | | | | | | | | | | | | | | | | | | | | | | | | | | | | | | | | | | | | | | | | | | | | | | | | | | | | | | | | | | | | | | | | | | | | | | | | | | | | | | | | | | | | | | | | | | | | | | | | | | | | | | | | | | | | | | | | | | | | | | | | | | | | | | | | | | | | | | | | | | | | | | | | | | | | | | | | | | | | | | | | | | | | | | | | | | | | | | | | | | | | | | | | | | | | | | | | | | | | | | | | | | | | | | | | | | | | | | | | | | | | | | | | | | | | | | | | | | | | | | | | | | | | | | | | | | | | | | | | | | | | | | | | | | | | | | | | | | | | | | | | | | | | | | | | | | | | | | | | | | | | | | | | | | | | | | | | | | | | | | | | | | | | | | | | | | | | | | | | | | | | | | | | | | | | | | | | | | | | | | | | | | | | | | | | | | | | | | | | | | | | | | | | | | | | | | | | | | | | | | | | | |
| 65WQ30-54-11JY | 142 | 340 | 130 | 210 | 280 | 345 | 175 | 614 | 234 | 1299 | 900 | 16 | 92kg | | | | | | | | | | | | | | | | | | | | | | | | | | | | | | | | | | | | | | | | | | | | | | | | | | | | | | | | | | | | | | | | | | | | | | | | | | | | | | | | | | | | | | | | | | | | | | | | | | | | | | | | | | | | | | | | | | | | | | | | | | | | | | | | | | | | | | | | | | | | | | | | | | | | | | | | | | | | | | | | | | | | | | | | | | | | | | | | | | | | | | | | | | | | | | | | | | | | | | | | | | | | | | | | | | | | | | | | | | | | | | | | | | | | | | | | | | | | | | | | | | | | | | | | | | | | | | | | | | | | | | | | | | | | | | | | | | | | | | | | | | | | | | | | | | | | | | | | | | | | | | | | | | | | | | | | | | | | | | | | | | | | | | | | | | | | | | | | | | | | | | | | | | | | | | | | | | | | | | | | | | | | | | | | | | | | | | | | | | | | | | | | | | | | | | | | | | | | | | | | | | | | | | | | | | | | | | | | | | | | | | | | | | | | | | | | | | | | | | | | | | | | | | | | | | | | | | | | | | | | | | | | | | | | | | | | | | | | | | | | | | | | | | | | | | | | | | | | | | | | | | | | | | | | | | | | | | | | | | | | | | | | | | | | | | | | | | | | | | | | | | | | | | | | | | | | | | | | | | | | | | | | | | | | | | | | | | | | | | | | | | | | | | | | | | | | | | | | | | | | | | | | | | | | | | | | | | | | | | | | | | | | | | | | | | | | | | | | | | | | | | | | | | | | | | | | | | | | | | | | | | | | | | | | | | | | | | | | | | | | | | | | | | | | | | | | | | | | | | | | | | | | | | | | | | | | | | | | | | | | | | | | | | | | | | | | | | | | | | | | | | | | | | | | | | | | | | | | | | | | | | | | | | | | | | | | | | | | | | | | | | | | | | | | | | | | | | | | | | | | | | | | | | | | | | | | | | | | | | | | | | | | | | | | | | | | | | | | | | | | | | | | | | | | | | | | | | | | | | | | | | | | | | | | | | | | | | | | | | | | | | | | | | | | | | | | | | | | | | | | | | | | | | | | | | | | | | | | | | | | | | | | | | | | | | | | | | | | | | | | | | | | | | | | | | | | | | | | | | | | | | | | | | | | | | | | | | | | | | | | | | | | | | | | | | | | | | | | | | | | | | | | | | | | | | | | | | | | | | | | | | | | | | | | | | | | | | | | | | | | | | | | | | | | | | | | | | | | | | | | | | | | | | | | | | | | | | | | | | | | | | | | | | | | | | | | | | | | | | | | | | | | | | | | | | | | | | | | | | | | | | | | | | | | | | | | | | | | | | | | | | | | | | | | | | | | | | | | | | | | | | | | | | | | | | | | | | | | | | | | | | | | | | | | | | | | | | | | | | | | | | | | | | | | | | | | | | | | | | | | | | | | | | | | | | | | | | | | | | | | | | | | | | | | | | | | | | | | | | | | | | | | | | | | | | | | | | | | | | | | | | | | | | | | | | | | | | | | | | | | | | | | | | | | | | | | | | | | | | | | | | | | | | | | | | | | | | | | | | | | | | | | | | | | | | | | | | | | | | | | | | | | | | | | | | | | | | | | | | | | | | | | | | | | | | | | | | | | | | | | | | | | | |
| 规格型号 | 6 | T1 | T2 | T3 | T4 | T5 | T6 | T7 | T8 | T9 | T10 | T11 | T12 | T13 | T14 | T15 | T16 | T17 | T18 | T19 | T20 | T21 | T22 | T23 | T24 | T25 | T26 | T27 | T28 | T29 | T30 | T31 | T32 | T33 | T34 | T35 | T36 | T37 | T38 | T39 | T40 | T41 | T42 | T43 | T44 | T45 | T46 | T47 | T48 | T49 | T50 | T51 | T52 | T53 | T54 | T55 | T56 | T57 | T58 | T59 | T60 | T61 | T62 | T63 | T64 | T65 | T66 | T67 | T68 | T69 | T70 | T71 | T72 | T73 | T74 | T75 | T76 | T77 | T78 | T79 | T80 | T81 | T82 | T83 | T84 | T85 | T86 | T87 | T88 | T89 | T90 | T91 | T92 | T93 | T94 | T95 | T96 | T97 | T98 | T99 | T100 | T101 | T102 | T103 | T104 | T105 | T106 | T107 | T108 | T109 | T110 | T111 | T112 | T113 | T114 | T115 | T116 | T117 | T118 | T119 | T120 | T121 | T122 | T123 | T124 | T125 | T126 | T127 | T128 | T129 | T130 | T131 | T132 | T133 | T134 | T135 | T136 | T137 | T138 | T139 | T140 | T141 | T142 | T143 | T144 | T145 | T146 | T147 | T148 | T149 | T150 | T151 | T152 | T153 | T154 | T155 | T156 | T157 | T158 | T159 | T160 | T161 | T162 | T163 | T164 | T165 | T166 | T167 | T168 | T169 | T170 | T171 | T172 | T173 | T174 | T175 | T176 | T177 | T178 | T179 | T180 | T181 | T182 | T183 | T184 | T185 | T186 | T187 | T188 | T189 | T190 | T191 | T192 | T193 | T194 | T195 | T196 | T197 | T198 | T199 | T200 | T201 | T202 | T203 | T204 | T205 | T206 | T207 | T208 | T209 | T210 | T211 | T212 | T213 | T214 | T215 | T216 | T217 | T218 | T219 | T220 | T221 | T222 | T223 | T224 | T225 | T226 | T227 | T228 | T229 | T230 | T231 | T232 | T233 | T234 | T235 | T236 | T237 | T238 | T239 | T240 | T241 | T242 | T243 | T244 | T245 | T246 | T247 | T248 | T249 | T250 | T251 | T252 | T253 | T254 | T255 | T256 | T257 | T258 | T259 | T260 | T261 | T262 | T263 | T264 | T265 | T266 | T267 | T268 | T269 | T270 | T271 | T272 | T273 | T274 | T275 | T276 | T277 | T278 | T279 | T280 | T281 | T282 | T283 | T284 | T285 | T286 | T287 | T288 | T289 | T290 | T291 | T292 | T293 | T294 | T295 | T296 | T297 | T298 | T299 | T300 | T301 | T302 | T303 | T304 | T305 | T306 | T307 | T308 | T309 | T310 | T311 | T312 | T313 | T314 | T315 | T316 | T317 | T318 | T319 | T320 | T321 | T322 | T323 | T324 | T325 | T326 | T327 | T328 | T329 | T330 | T331 | T332 | T333 | T334 | T335 | T336 | T337 | T338 | T339 | T340 | T341 | T342 | T343 | T344 | T345 | T346 | T347 | T348 | T349 | T350 | T351 | T352 | T353 | T354 | T355 | T356 | T357 | T358 | T359 | T360 | T361 | T362 | T363 | T364 | T365 | T366 | T367 | T368 | T369 | T370 | T371 | T372 | T373 | T374 | T375 | T376 | T377 | T378 | T379 | T380 | T381 | T382 | T383 | T384 | T385 | T386 | T387 | T388 | T389 | T390 | T391 | T392 | T393 | T394 | T395 | T396 | T397 | T398 | T399 | T400 | T401 | T402 | T403 | T404 | T405 | T406 | T407 | T408 | T409 | T410 | T411 | T412 | T413 | T414 | T415 | T416 | T417 | T418 | T419 | T420 | T421 | T422 | T423 | T424 | T425 | T426 | T427 | T428 | T429 | T430 | T431 | T432 | T433 | T434 | T435 | T436 | T437 | T438 | T439 | T440 | T441 | T442 | T443 | T444 | T445 | T446 | T447 | T448 | T449 | T450 | T451 | T452 | T453 | T454 | T455 | T456 | T457 | T458 | T459 | T460 | T461 | T462 | T463 | T464 | T465 | T466 | T467 | T468 | T469 | T470 | T471 | T472 | T473 | T474 | T475 | T476 | T477 | T478 | T479 | T480 | T481 | T482 | T483 | T484 | T485 | T486 | T487 | T488 | T489 | T490 | T491 | T492 | T493 | T494 | T495 | T496 | T497 | T498 | T499 | T500 | T501 | T502 | T503 | T504 | T505 | T506 | T507 | T508 | T509 | T510 | T511 | T512 | T513 | T514 | T515 | T516 | T517 | T518 | T519 | T520 | T521 | T522 | T523 | T524 | T525 | T526 | T527 | T528 | T529 | T530 | T531 | T532 | T533 | T534 | T535 | T536 | T537 | T538 | T539 | T540 | T541 | T542 | T543 | T544 | T545 | T546 | T547 | T548 | T549 | T550 | T551 | T552 | T553 | T554 | T555 | T556 | T557 | T558 | T559 | T560 | T561 | T562 | T563 | T564 | T565 | T566 | T567 | T568 | T569 | T570 | T571 | T572 | T573 | T574 | T575 | T576 | T577 | T578 | T579 | T580 | T581 | T582 | T583 | T584 | T585 | T586 | T587 | T588 | T589 | T590 | T591 | T592 | T593 | T594 | T595 | T596 | T597 | T598 | T599 | T600 | T601 | T602 | T603 | T604 | T605 | T606 | T607 | T608 | T609 | T610 | T611 | T612 | T613 | T614 | T615 | T616 | T617 | T618 | T619 | T620 | T621 | T622 | T623 | T624 | T625 | T626 | T627 | T628 | T629 | T630 | T631 | T632 | T633 | T634 | T635 | T636 | T637 | T638 | T639 | T640 | T641 | T642 | T643 | T644 | T645 | T646 | T647 | T648 | T649 | T650 | T651 | T652 | T653 | T654 | T655 | T656 | T657 | T658 | T659 | T660 | T661 | T662 | T663 | T664 | T665 | T666 | T667 | T668 | T669 | T670 | T671 | T672 | T673 | T674 | T675 | T676 | T677 | T678 | T679 | T680 | T681 | T682 | T683 | T684 | T685 | T686 | T687 | T688 | T689 | T690 | T691 | T692 | T693 | T694 | T695 | T696 | T697 | T698 | T699 | T700 | T701 | T702 | T703 | T704 | T705 | T706 | T707 | T708 | T709 | T710 | T711 | T712 | T713 | T714 | T715 | T716 | T717 | T718 | T719 | T720 | T721 | T722 | T723 | T724 | T725 | T726 | T727 | T728 | T729 | T730 | T731 | T732 | T733 | T734 | T735 | T736 | T737 | T738 | T739 | T740 | T741 | T742 | T743 | T744 | T745 | T746 | T747 | T748 | T749 | T750 | T751 | T752 | T753 | T754 | T755 | T756 | T757 | T758 | T759 | T760 | T761 | T762 | T763 | T764 | T765 | T766 | T767 | T768 | T769 | T770 | T771 | T772 | T773 | T774 | T775 | T776 | T777 | T778 | T779 | T780 | T781 | T782 | T783 | T784 | T785 | T786 | T787 | T788 | T789 | T790 | T791 | T792 | T793 | T794 | T795 | T796 | T797 | T798 | T799 | T800 | T801 | T802 | T803 | T804 | T805 | T806 | T807 | T808 | T809 | T810 | T811 | T812 | T813 | T814 | T815 | T816 | T817 | T818 | T819 | T820 | T821 | T822 | T823 | T824 | T825 | T826 | T827 | T828 | T829 | T830 | T831 | T832 | T833 | T834 | T835 | T836 | T837 | T838 | T839 | T840 | T841 | T842 | T843 | T844 | T845 | T846 | T847 | T848 | T849 | T850 | T851 | T852 | T853 | T854 | T855 | T856 | T857 | T858 | T859 | T860 | T861 | T862 | T863 | T864 | T865 | T866 | T867 | T868 | T869 | T870 | T871 | T872 | T873 | T874 | T875 | T876 | T877 | T878 | T879 | T880 | T881 | T882 | T883 | T884 | T885 | T886 | T887 | T888 | T889 | T890 | T891 | T892 | T893 | T894 | T895 | T896 | T897 | T898 | T899 | T900 | T901 | T902 | T903 | T904 | T905 | T906 | T907 | T908 | T909 | T910 | T911 | T912 | T913 | T914 | T915 | T916 | T917 | T918 | T919 | T920 | T921 | T922 | T923 | T924 | T925 | T926 | T927 | T928 | T929 | T930 | T931 | T932 | T933 | T934 | T935 | T936 | T937 | T938 | T939 | T940 | T941 | T942 | T943 | T944 | T945 | T946 | T947 | T948 | T949 | T950 | T951 | T952 | T953 | T954 | T955 | T956 | T957 | T958 | T959 | T960 | T961 | T962 | T963 | T964 | T965 | T966 | T967 | T968 | T969 | T970 | T971 | T972 | T973 | T974 | T975 | T976 | T977 | T978 | T979 | T980 | T981 | T982 | T983 | T984 | T985 | T986 | T987 | T988 | T989 | T990 | T991 | T992 | T993 | T994 | T995 | T996 | T997 | T998 | T999 | T1000 | T1001 | T1002 | T1003 | T1004 | T1005 | T1006 | T1007 | T1008 | T1009 | T1010 | T1011 | T1012 | T1013 | T1014 | T1015 | T1016 | T1017 | T1018 | T1019 | T1020 | T1021 | T1022 | T1023 | T1024 | T1025 | T1026 | T1027 | T1028 | T1029 | T1030 | T1031 | T1032 | T1033 | T1034 | T1035 | T1036 | T1037 | T1038 | T1039 | T1040 | T1041 | T1042 | T1043 | T1044 | T1045 | T1046 | T1047 | T1048 | T1049 | T1050 | T1051 | T1052 | T1053 | T1054 | T1055 | T1056 | T1057 | T1058 | T1059 | T1060 | T1061 | T1062 | T1063 | T1064 | T1065 | T1066 | T1067 | T1068 | T1069 | T1070 | T1071 | T1072 | T1073 | T1074 | T1075 | T1076 | T1077 | T1078 | T1079 | T1080 | T1081 | T1082 | T1083 | T1084 | T1085 | T1086 | T1087 | T1088 | T1089 | T1090 | T1091 | T1092 | T1093 | T1094 | T1095 | T1096 | T1097 | T1098 | T1099 | T1100 | T1101 | T1102 | T1103 | T1104 | T1105 | T1106 | T1107 | T1108 | T1109 | T1110 | T1111 | T1112 | T1113 | T1114 | T1115 | T1116 | T1117 | T1118 | T1119 | T1120 | T1121 | T1122 | T1123 | T1124 | T1125 | T1126 | T1127 | T1128 | T1129 | T1130 | T1131 | T1132 | T1133 | T1134 | T1135 | T1136 | T1137 | T1138 | T1139 | T1140 | T1141 | T1142 | T1143 | T1144 | T1145 | T1146 | T1147 | T1148 | T1149 | T1150 | T1151 | T1152 | T1153 | T1154 | T1155 | T1156 | T1157 | T1158 | T1159 | T1160 | T1161 | T1162 | T1163 | T1164 | T1165 | T1166 | T1167 | T1168 | T1169 | T1170 | T1171 | T1172 | T1173 | T1174 | T1175 | T1176 | T1177 | T1178 | T1179 | T1180 | T1181 | T1182 | T1183 | T1184 | T1185 | T1186 | T1187 | T1188 | T1189 | T1190 | T1191 | T1192 | T1193 | T1194 | T1195 | T1196 | T1197 | T1198 | T1199 | T1200 | T1201 | T1202 | T1203 | T1204 | T1205 | T1206 | T1207 | T1208 | T1209 | T1210 | T1211 | T1212 | T1213 | T1214 | T1215 | T1216 | T1217 | T1218 | T1219 | T1220 | T1221 | T1222 | T1223 | T1224 | T1225 | T1226 | T1227 | T1228 | T1229 | T1230 | T1231 | T1232 | T1233 | T1234 | T1235 | T1236 | T1237 | T1238 | T1239 | T1240 | T1241 | T1242 | T1243 | T1244 | T1245 | T1246 | T1247 | T1248 | T1249 | T1250 | T1251 | T1252 | T1253 | T1254 | T1255 | T1256 | T1257 | T1258 | T1259 | T1260 | T1261 | T1262 | T1263 | T1264 | T1265 | T1266 | T1267 | T1268 | T1269 | T1270 | T1271 | T1272 | T1273 | T1274 | T1275 | T1276 | T1277 | T1278 | T1279 | T1280 | T1281 | T1282 | T1283 | T1284 | T1285 | T1286 | T1287 | T1288 | T1289 | T1290 | T1291 | T1292 | T1293 | T1294 | T1295 | T1296 | T1297 | T1298 | T1299 | T1300 | T1301 | T1302 | T1303 | T1304 | T1305 | T1306 | T1307 | T1308 | T1309 | T1310 | T1311 | T1312 | T1313 | T1314 | T1315 | T1316 | T1317 | T1318 | T1319 | T1320 | T1321 | T1322 | T1323 | T1324 | T1325 | T1326 | T1327 | T1328 | T1329 | T1330 | T1331 | T1332 | T1333 | T1334 | T1335 | T1336 | T1337 | T1338 | T1339 | T1340 | T1341 | T1342 | T1343 | T1344 | T1345 | T1346 | T1347 | T1348 | T1349 | T1350 | T1351 | T1352 | T1353 | T1354 | T1355 | T1356 | T1357 | T1358 | T1359 | T1360 | T1361 | T1362 | T1363 | T1364 | T1365 | T1366 | T1367 | T1368 | T1369 | T1370 | T1371 | T1372 | T1373 | T1374 | T1375 | T1376 | T1377 | T1378 | T1379 | T1380 | T1381 | T1382 | T1383 | T1384 | T1385 | T1386 | T1387 | T1388 | T1389 | T1390 | T1391 | T1392 | T1393 | T1394 | T1395 | T1396 | T1397 | T1398 | T1399 | T1400 | T1401 | T1402 | T1403 | T1404 | T1405 | T1406 | T1407 | T1408 | T1409 | T1410 | T1411 | T1412 | T1413 | T1414 | T1415 | T1416 | T |