	Product information 50WQ15-20-2.2/QG(I)	Manufacturer	CNP
		Address	Yuhang District, Hangzhou,
Project Name		Contact	86-571-88637351
		Date	2022/03/09
Station Number		Client Name	DPA
		Client Addr.	
		Contacts	Alireza
		Contact	

Product No.	50WQ15-20-2.2/QG(I)
-------------	---------------------

Product picture(Note:the picture may not be the same as the	Series description
	Single channel or double channel impeller.Auto-coupling system on request.

Performance Data	
Rated flow(m ³ /h)	15
Rated head(m)	20
Efficiency(%)	48.3
Rated power(kW)(kW)	1.75
Rate Speed(rpm)	2880
technology	
Pump rotator speed	2880
Nameplate standards	CE
Material	
Impeller	HT200
Pump shaft	20cr13
Rubber code	P
Pump case	HT200
Installation	
Connection Code	F
Maximum Pressure/Temperatu	6bar/40
Flange Standard	DIN
Pressure Class	PN6
Medium	
Medium Temperature	40
Maximum diameter of partic	12
Maximum Environment Temper	40
Structure dimension	
Standard	DN
Outlet size	DN50
Motor	
Number of Motor Phase	Three Phase
Protection Class	IP68
Insulation Class	F
Motor Power	2.2
Power Frequency	50HZ
Rated Voltage (V)	380V
Rated Current (A)	4.6

	Product information 50WQ15-20-2.2/QG(I)	Manufacturer	CNP
		Address	Yuhang District, Hangzhou,
		Contact	86-571-88637351
		Date	2022/03/09
Project Name		Client Name	DPA
		Client Addr.	
Station Number		Contacts	Alireza
		Contact	

Starting mode direct boot

Seal

Mechanical Seal H-25

Others

Weight (kg) 37.5





Performance Curve 50WQ15-20-2.2/QG(I)

Manufacturer	CNP
Address	Yuhang District, Hangzhou,
Contact	86-571-88637351
Date	2022/03/09
Client Name	DPA
Client Addr.	
Contacts	Alireza
Contact	

Project Name

Station Number

Medium Name Clear Water , Temperature 20°C, Density 1000kg/m³, Viscosity 1mm²/s, (ISO99062012 Grande 3B)

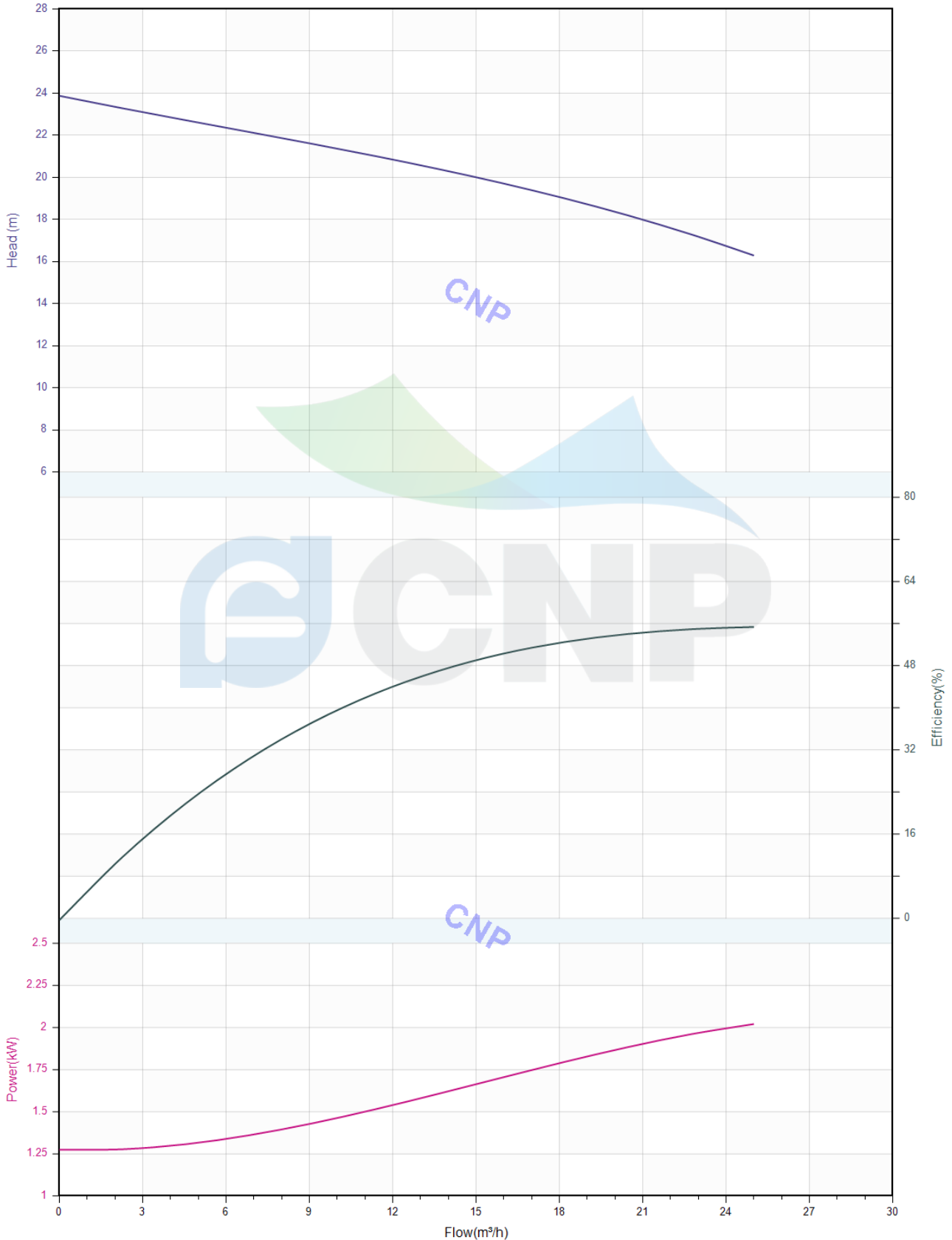



Pump technical parameters 50WQ15-20-2.2/QG(I)

Manufacturer	CNP
Address	Yuhang District, Hangzhou,
Contact	86-571-88637351
Date	2022/03/09
Client Name	DPA
Client Addr.	
Contacts	Alireza
Contact	

Project Name

Station Number

Rated parameters

Pump model	50WQ15-20-2.2/QG(I)
Product No.	50WQ15-20-2.2/QG(I)
Rated flow(m ³ /h)	15
Rated pressure(m)	20
Rated efficiency(%)	48.3
Power(kW)	1.75
Speed(rpm)	2880

Medium

Medium Name	Clear Water
Working temperature(°C)	20
Medium density(kg/m ³)	1000
Viscosity(mm ² /s)	1

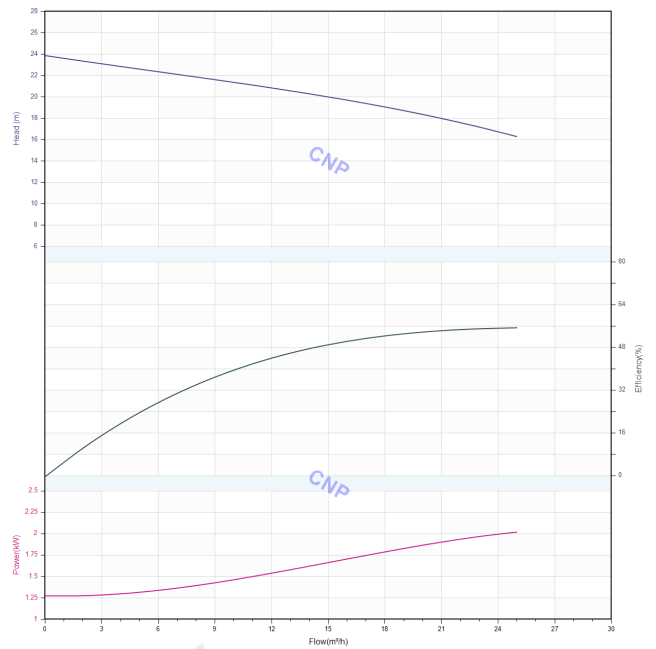

	Structure picture 50WQ15-20-2.2/QG(I)	Manufacturer	CNP
		Address	Yuhang District, Hangzhou,
Project Name		Contact	86-571-88637351
		Date	2022/03/09
Station Number		Client Name	DPA
		Client Addr.	
		Contacts	Alireza
		Contact	

CNP Nanfang Zhongjin Environment Co., Ltd.

	SECTIONAL DRAWING	No.	No.
TYPE	submersible sewage pump	MODEL	WQ-1.5/2.2/3.0/4.0kW



order specifications

No.	names of parts	number	material	No.	names of parts	number	material
1	cable	1	YZW	22	water inlet cover	1	HT200
3	cable cover	1	SUS304	20	casing	1	HT200
50	top cover	1	HT200	35	oil filler plug	1	SUS304
52A	upper bearing	1		36	machine oil 32#		
58	cable transit board	1		60	lower cover	1	HT200
64	base	1	HT200	56	stator	1	
52B	lower bearing	1		55	rotor	1	
25	mechanical seal	1	Carbon/SIC	54	shaft	1	
30	oil lift	1		53	thermal protector	1	
26	framework oil seal	1	NBRI-2	72	eye bolt	2	45#(forging galvanized)
93	guide hook	1	HT200	91	water outlet base	1	HT200
21	impeller	1	HT200	94	guiding	1	HT200
510	lift chain	1	SUS304	92	pipe	1	SUS304(unaffiliated)

Nanfang Zhongjin Environment CO.,LTD.

unit : mm



Installation picture 50WQ15-20-2.2/QG(I)

Manufacturer	CNP
Address	Yuhang District, Hangzhou,
Contact	86-571-88637351
Date	2022/03/09
Client Name	DPA
Client Addr.	
Contacts	Alireza
Contact	

Project Name

Station Number

CNP Nanfang Zhongjin Environment Co., Ltd.

DIMENSION DRAWING		No.	No.
TYPE submersible sewage pump		MODEL	50WQ15-20-2.2/QG

MODEL	d	A	A1	A2	A3	A4	B	B1	B2	D	D1	W1	W2	H	Body weight
50WQ15-20-2.2/QG	50	372	428	108	155	223	235	217	217	237	118	370	150	509	19kg

diameter	elbow weight	bend weight
50	1.5kg	3.5kg

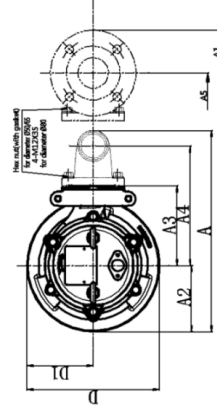
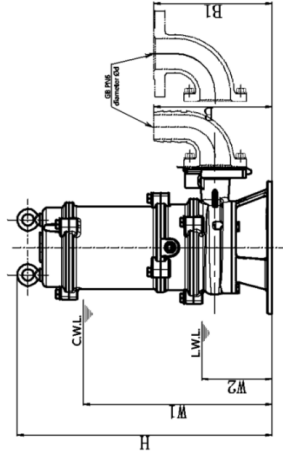

C.W.L. :minimum water level under continuous operation
L.W.L. :minimum water level under possible operation

Nanfang Zhongjin Environment CO.,LTD. unit : mm

CNP Nanfang Zhongjin Environment Co., Ltd.

DIMENSION DRAWING		No.	No.
TYPE submersible sewage pump		MODEL	50WQ15-20-2.2/QG

MODEL	A	A1	A2	A3	A4	D	D1	W1	W2	H	H1	H2	Body weight							
50WQ15-20-2.2/QG	116.5	261	175	245	211	233	116.5	430	220	566	966	58	37.5kg							
50WQ15-20-2.2/QG	50	290	185	70	50	160	200	179	243.5	35	25	120	120	40	231	10	250	202.5	15	13.9kg

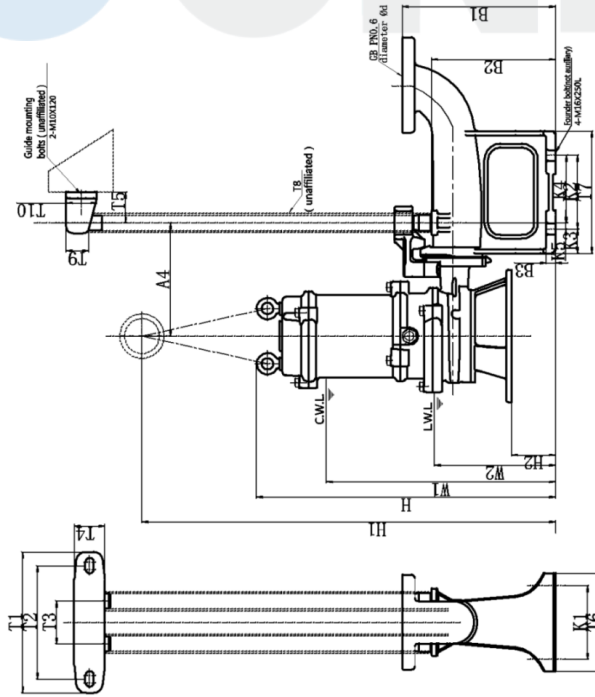

C.W.L. :minimum water level under continuous operation
L.W.L. :minimum water level under possible operation

Nanfang Zhongjin Environment CO.,LTD. unit : mm