

	<b>Product information</b> <b>50WQ10-10-0.75W(I)</b>	Manufacturer	CNP
		Address	Yuhang District, Hangzhou,
<b>Project Name</b>		Contact	86-571-88637351
		Date	2022/03/09
<b>Station Number</b>		Client Name	DPA
		Client Addr.	
		Contacts	Alireza
		Contact	

Product No.	50WQ10-10-0.75W(I)
-------------	--------------------

Product picture(Note:the picture may not be the same as the	Series description
	Single channel or double channel impeller.Auto-coupling system on request.

<b>Performance Data</b>	
Rated flow(m <sup>3</sup> /h)	10
Rated head(m)	10
Efficiency(%)	43.2
Rated power(kW)(kW)	0.61
Rate Speed(rpm)	2850
<b>technology</b>	
Pump rotator speed	2850
Nameplate standards	CE
<b>Material</b>	
Impeller	HT200
Pump shaft	20cr13
Rubber code	P
Pump case	HT200
<b>Installation</b>	
Connection Code	F
Maximum Pressure/Temperatu	6bar/40
Flange Standard	DIN
Pressure Class	PN6
<b>Medium</b>	
Medium Temperature	40
Maximum diameter of partic	15
Maximum Environment Temper	40
<b>Structure dimension</b>	
Standard	DN
Outlet size	DN50
<b>Motor</b>	
Number of Motor Phase	Three Phase
Protection Class	IP68
Insulation Class	F
Motor Power	0.75
Power Frequency	50HZ
Rated Voltage (V)	380V
Rated Current (A)	1.8

	<b>Product information</b> <b>50WQ10-10-0.75W(I)</b>	Manufacturer	CNP
		Address	Yuhang District, Hangzhou,
		Contact	86-571-88637351
		Date	2022/03/09
<b>Project Name</b>		Client Name	DPA
		Client Addr.	
<b>Station Number</b>		Contacts	Alireza
		Contact	

Starting mode                      direct boot

**Seal**

Mechanical Seal                      H-17

**Others**

Weight (kg)                              23





### Performance Curve 50WQ10-10-0.75W(I)

Manufacturer	CNP
Address	Yuhang District, Hangzhou,
Contact	86-571-88637351
Date	2022/03/09
Client Name	DPA
Client Addr.	
Contacts	Alireza
Contact	

Project Name

Station Number

Medium Name Clear Water , Temperature 20°C, Density 1000kg/m<sup>3</sup>, Viscosity 1mm<sup>2</sup>/s, (ISO99062012 Grande 3B)

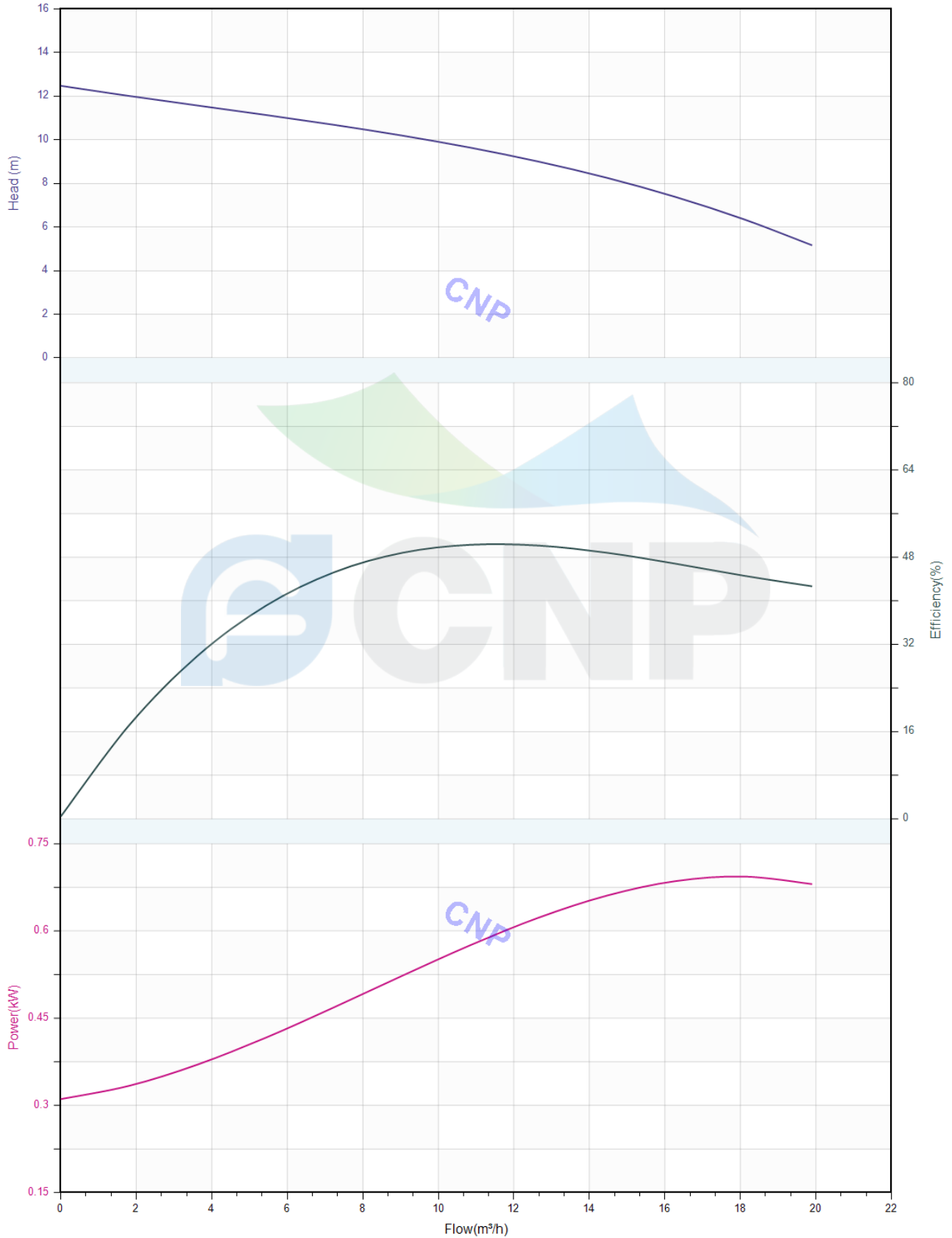

	<b>Pump technical parameters</b> <b>50WQ10-10-0.75W(I)</b>	Manufacturer	CNP
		Address	Yuhang District, Hangzhou,
Project Name		Contact	86-571-88637351
		Date	2022/03/09
Station Number		Client Name	DPA
		Client Addr.	
		Contacts	Alireza
		Contact	

**Rated parameters**

Pump model	50WQ10-10-0.75W(I)
Product No.	50WQ10-10-0.75W(I)
Rated flow(m <sup>3</sup> /h)	10
Rated pressure(m)	10
Rated efficiency(%)	43.2
Power(kW)	0.61
Speed(rpm)	2850

**Medium**

Medium Name	Clear Water
Working temperature(°C)	20
Medium density(kg/m <sup>3</sup> )	1000
Viscosity(mm <sup>2</sup> /s)	1

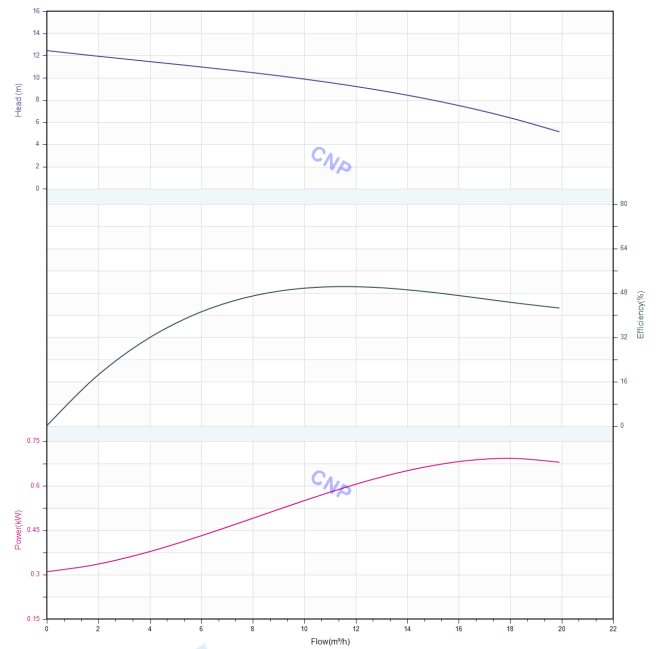

	<b>Structure picture</b> <b>50WQ10-10-0.75W(I)</b>	Manufacturer	CNP
		Address	Yuhang District, Hangzhou,
Project Name		Contact	86-571-88637351
		Date	2022/03/09
Station Number		Client Name	DPA
		Client Addr.	
		Contacts	Alireza
		Contact	

## **CNP Nanfang Zhongjin Environment Co., Ltd**

	<b>STRUCTURE DRAWING</b>	No.	No.
TYPE	submersible sewage pump	MODEL	WQ-0.55/0.75/1.1KW

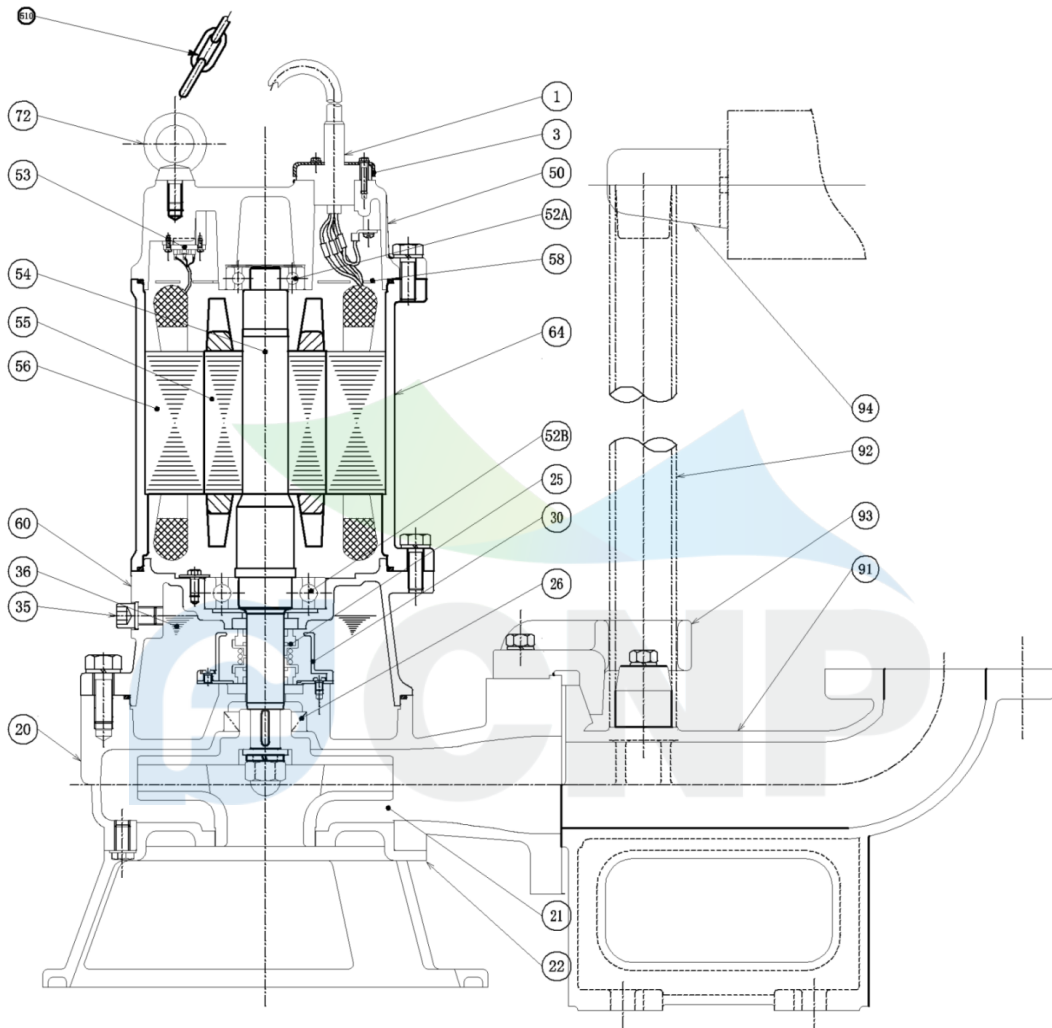

order specifications							
No.	names of parts	number	material	No.	names of parts	number	material
1	cable	1	YZW	22	water inlet cover	1	HT200
3	cable cover	1	SUS304	20	casing	1	HT200
50	top cover	1	HT200	35	oil filler plug	1	SUS304
52A	upper bearing	1		36	machine oil 32#		
58	cable transit board	1	PPS	60	lower cover	1	HT200
64	base	1	HT200	56	stator	1	
52B	lower bearing	1		55	rotor	1	
25	mechanical seal	1	Carbon/SIC	54	shaft	1	
30	oil lift	1		53	thermal protector	1	
26	framework oil seal	1	NBRI-2	72	eye bolt	2	45#(forging galvanized)
93	guide hook	1	HT200	91	water outlet base	1	HT200
21	impeller	1	HT200	94	guiding	1	HT200
510		1	SUS304	92	pipe	1	SUS304(unaffiliated)

Nanfang Zhongjin Environment CO.,LTD.

unit : mm



# Installation picture 50WQ10-10-0.75W(I)

Manufacturer	CNP
Address	Yuhang District, Hangzhou,
Contact	86-571-88637351
Date	2022/03/09
Client Name	DPA
Client Addr.	
Contacts	Alireza
Contact	

Project Name

Station Number

**CNP Nanfang Zhongjin Environment Co., Ltd.**

DIMENSION DRAWING		No.	No.																																																																																																																																																																																																																																																																																																																																																																																																																																																																																																																																																																																																																																																																																																																																																																																																																																																																																																																																																																																																																																																				
TYPE submersible sewage pump		MODEL	50WQ10-10-0.75W																																																																																																																																																																																																																																																																																																																																																																																																																																																																																																																																																																																																																																																																																																																																																																																																																																																																																																																																																																																																																																																				
MODEL	d	A	A1	A2	A3	A4	A5	B	B1	D	D1	D2	H	H1	H2	W1	W2	W3	W4	W5	W6	W7	W8	W9	W10	W11	W12	W13	W14	W15	W16	W17	W18	W19	W20	W21	W22	W23	W24	W25	W26	W27	W28	W29	W30	W31	W32	W33	W34	W35	W36	W37	W38	W39	W40	W41	W42	W43	W44	W45	W46	W47	W48	W49	W50	W51	W52	W53	W54	W55	W56	W57	W58	W59	W60	W61	W62	W63	W64	W65	W66	W67	W68	W69	W70	W71	W72	W73	W74	W75	W76	W77	W78	W79	W80	W81	W82	W83	W84	W85	W86	W87	W88	W89	W90	W91	W92	W93	W94	W95	W96	W97	W98	W99	W100	W101	W102	W103	W104	W105	W106	W107	W108	W109	W110	W111	W112	W113	W114	W115	W116	W117	W118	W119	W120	W121	W122	W123	W124	W125	W126	W127	W128	W129	W130	W131	W132	W133	W134	W135	W136	W137	W138	W139	W140	W141	W142	W143	W144	W145	W146	W147	W148	W149	W150	W151	W152	W153	W154	W155	W156	W157	W158	W159	W160	W161	W162	W163	W164	W165	W166	W167	W168	W169	W170	W171	W172	W173	W174	W175	W176	W177	W178	W179	W180	W181	W182	W183	W184	W185	W186	W187	W188	W189	W190	W191	W192	W193	W194	W195	W196	W197	W198	W199	W200	W201	W202	W203	W204	W205	W206	W207	W208	W209	W210	W211	W212	W213	W214	W215	W216	W217	W218	W219	W220	W221	W222	W223	W224	W225	W226	W227	W228	W229	W230	W231	W232	W233	W234	W235	W236	W237	W238	W239	W240	W241	W242	W243	W244	W245	W246	W247	W248	W249	W250	W251	W252	W253	W254	W255	W256	W257	W258	W259	W260	W261	W262	W263	W264	W265	W266	W267	W268	W269	W270	W271	W272	W273	W274	W275	W276	W277	W278	W279	W280	W281	W282	W283	W284	W285	W286	W287	W288	W289	W290	W291	W292	W293	W294	W295	W296	W297	W298	W299	W300	W301	W302	W303	W304	W305	W306	W307	W308	W309	W310	W311	W312	W313	W314	W315	W316	W317	W318	W319	W320	W321	W322	W323	W324	W325	W326	W327	W328	W329	W330	W331	W332	W333	W334	W335	W336	W337	W338	W339	W340	W341	W342	W343	W344	W345	W346	W347	W348	W349	W350	W351	W352	W353	W354	W355	W356	W357	W358	W359	W360	W361	W362	W363	W364	W365	W366	W367	W368	W369	W370	W371	W372	W373	W374	W375	W376	W377	W378	W379	W380	W381	W382	W383	W384	W385	W386	W387	W388	W389	W390	W391	W392	W393	W394	W395	W396	W397	W398	W399	W400	W401	W402	W403	W404	W405	W406	W407	W408	W409	W410	W411	W412	W413	W414	W415	W416	W417	W418	W419	W420	W421	W422	W423	W424	W425	W426	W427	W428	W429	W430	W431	W432	W433	W434	W435	W436	W437	W438	W439	W440	W441	W442	W443	W444	W445	W446	W447	W448	W449	W450	W451	W452	W453	W454	W455	W456	W457	W458	W459	W460	W461	W462	W463	W464	W465	W466	W467	W468	W469	W470	W471	W472	W473	W474	W475	W476	W477	W478	W479	W480	W481	W482	W483	W484	W485	W486	W487	W488	W489	W490	W491	W492	W493	W494	W495	W496	W497	W498	W499	W500	W501	W502	W503	W504	W505	W506	W507	W508	W509	W510	W511	W512	W513	W514	W515	W516	W517	W518	W519	W520	W521	W522	W523	W524	W525	W526	W527	W528	W529	W530	W531	W532	W533	W534	W535	W536	W537	W538	W539	W540	W541	W542	W543	W544	W545	W546	W547	W548	W549	W550	W551	W552	W553	W554	W555	W556	W557	W558	W559	W560	W561	W562	W563	W564	W565	W566	W567	W568	W569	W570	W571	W572	W573	W574	W575	W576	W577	W578	W579	W580	W581	W582	W583	W584	W585	W586	W587	W588	W589	W590	W591	W592	W593	W594	W595	W596	W597	W598	W599	W600	W601	W602	W603	W604	W605	W606	W607	W608	W609	W610	W611	W612	W613	W614	W615	W616	W617	W618	W619	W620	W621	W622	W623	W624	W625	W626	W627	W628	W629	W630	W631	W632	W633	W634	W635	W636	W637	W638	W639	W640	W641	W642	W643	W644	W645	W646	W647	W648	W649	W650	W651	W652	W653	W654	W655	W656	W657	W658	W659	W660	W661	W662	W663	W664	W665	W666	W667	W668	W669	W670	W671	W672	W673	W674	W675	W676	W677	W678	W679	W680	W681	W682	W683	W684	W685	W686	W687	W688	W689	W690	W691	W692	W693	W694	W695	W696	W697	W698	W699	W700	W701	W702	W703	W704	W705	W706	W707	W708	W709	W710	W711	W712	W713	W714	W715	W716	W717	W718	W719	W720	W721	W722	W723	W724	W725	W726	W727	W728	W729	W730	W731	W732	W733	W734	W735	W736	W737	W738	W739	W740	W741	W742	W743	W744	W745	W746	W747	W748	W749	W750	W751	W752	W753	W754	W755	W756	W757	W758	W759	W760	W761	W762	W763	W764	W765	W766	W767	W768	W769	W770	W771	W772	W773	W774	W775	W776	W777	W778	W779	W780	W781	W782	W783	W784	W785	W786	W787	W788	W789	W790	W791	W792	W793	W794	W795	W796	W797	W798	W799	W800	W801	W802	W803	W804	W805	W806	W807	W808	W809	W810	W811	W812	W813	W814	W815	W816	W817	W818	W819	W820	W821	W822	W823	W824	W825	W826	W827	W828	W829	W830	W831	W832	W833	W834	W835	W836	W837	W838	W839	W840	W841	W842	W843	W844	W845	W846	W847	W848	W849	W850	W851	W852	W853	W854	W855	W856	W857	W858	W859	W860	W861	W862	W863	W864	W865	W866	W867	W868	W869	W870	W871	W872	W873	W874	W875	W876	W877	W878	W879	W880	W881	W882	W883	W884	W885	W886	W887	W888	W889	W890	W891	W892	W893	W894	W895	W896	W897	W898	W899	W900	W901	W902	W903	W904	W905	W906	W907	W908	W909	W910	W911	W912	W913	W914	W915	W916	W917	W918	W919	W920	W921	W922	W923	W924	W925	W926	W927	W928	W929	W930	W931	W932	W933	W934	W935	W936	W937	W938	W939	W940	W941	W942	W943	W944	W945	W946	W947	W948	W949	W950	W951	W952	W953	W954	W955	W956	W957	W958	W959	W960	W961	W962	W963	W964	W965	W966	W967	W968	W969	W970	W971	W972	W973	W974	W975	W976	W977	W978	W979	W980	W981	W982	W983	W984	W985	W986	W987	W988	W989	W990	W991	W992	W993	W994	W995	W996	W997	W998	W999	W1000

