	Product Information 150WQ150-35-37(I)	Manufacturer	CNP
		Address	Yuhang District, Hangzhou, Zhejiang,
Project Name		Contact	86-571-88637351
		Date	2022/03/09
Item NO		Client Name	DPA
		Client Addr.	
		Contacts	Alireza
		Contact	

Part NO.	150WQ150-35-37(I)
----------	-------------------

Product Picture	Note
	<p>The sewage submersible pump is composed of two parts: the motor and the pump.</p> <p>The two are separated by an oil chamber and a mechanical seal assembly.</p> <p>Divided into fixed automatic coupling installation and mobile installation</p>

technology	
Pump rotator speed	1470
Nameplate standards	CE
Material	
Impeller	HT200
Pump shaft	20cr13
Rubber code	P
Pump case	HT200
Installation	
Connection Code	F
Maximum Pressure/Temperatu	6bar/40
Flange Standard	DIN
Pressure Class	PN6
Medium	
Medium Temperature	40
Maximum diameter of partic	65
Maximum Environment Temper	40
Structure dimension	
Standard caliber	DN
Outlet Diameter	DN150
Motor	
Number of Motor Phase	Three Phase
Protection Class	IP68
Insulation Class	F
Motor Power	37
Power Frequency	50HZ
Rated Voltage (V)	380V
Rated Current (A)	71.9
Starting mode	Star delta boot
Seal	
Mechanical Seal	H-60
Others	
Weight (kg)	700



Performance Curve 150WQ150-35-37(I)

Manufacturer	CNP
Address	Yuhang District, Hangzhou, Zhejiang,
Contact	86-571-88637351
Date	2022/03/09
Client Name	DPA
Client Addr.	
Contacts	Alireza
Contact	

Project Name

Item NO

The hydraulic performance curve have been tested with Clean Water at 20°C, density 1000kg/m³, and at 1bar atmospheric pressure. ISO99062012 Grade 3B

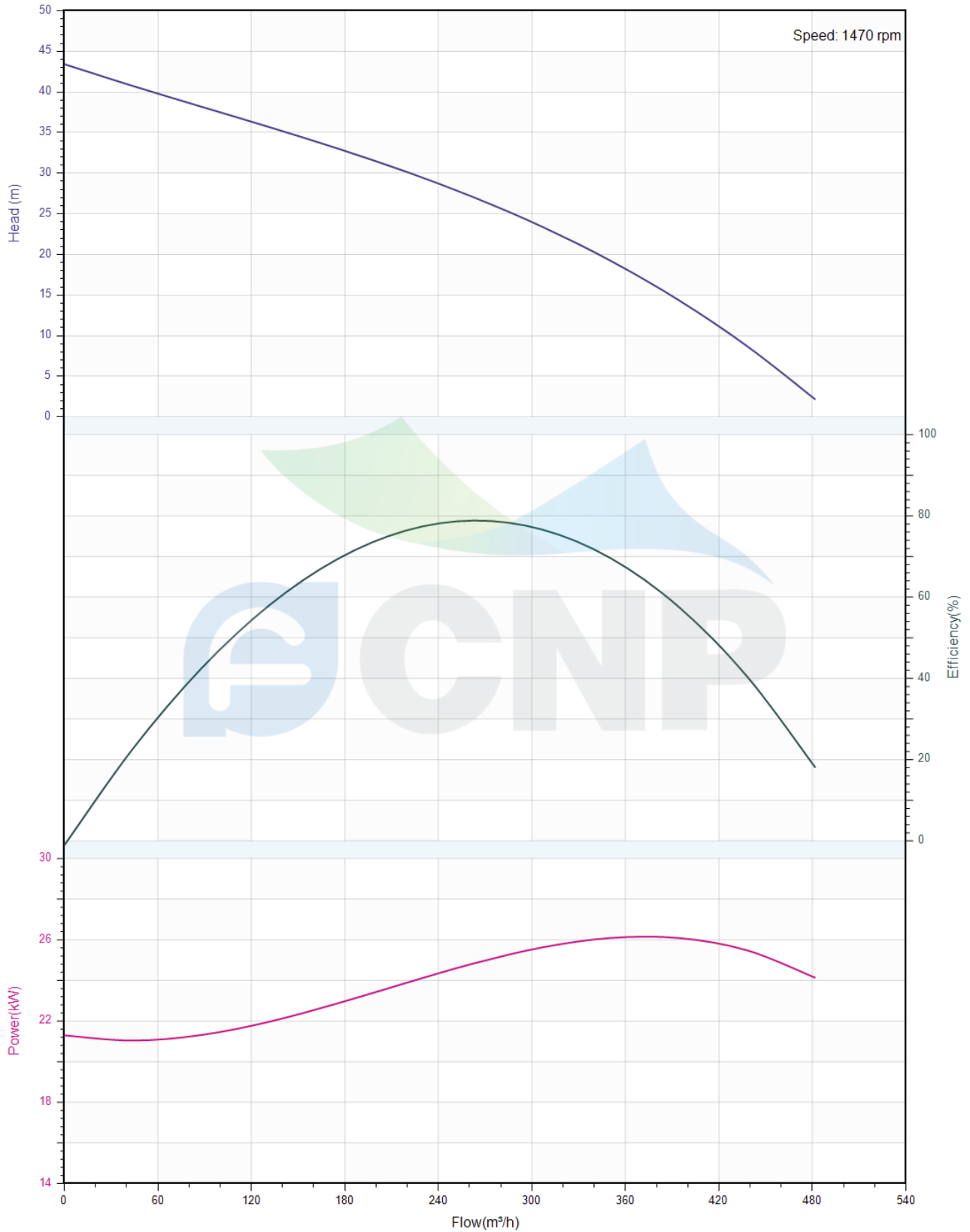



Pump Technical Parameters 150WQ150-35-37(I)

Manufacturer	CNP
Address	Yuhang District, Hangzhou, Zhejiang,
Contact	86-571-88637351
Date	2022/03/09
Client Name	DPA
Client Addr.	
Contacts	Alireza
Contact	

Rated parameters

Pump model	150WQ150-35-37(I)
Part NO.	150WQ150-35-37(I)
Rated flow (m ³ /h)	150
Rated head (m)	35
Rated efficiency (%)	49.5
Power (kW)	27.506
Speed (rpm)	1470

Medium

Pumped medium	Clean Water
Working temperature (°C)	20
Medium density (kg/m ³)	1000
Viscosity (mm ² /s)	1

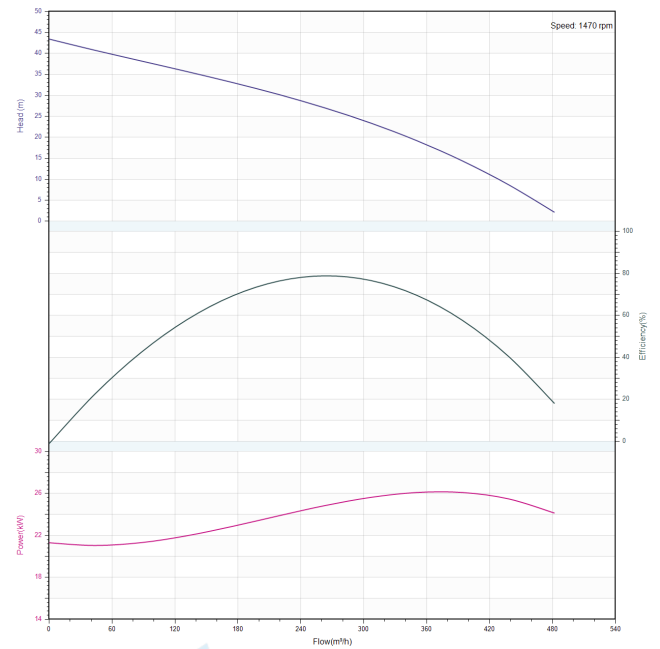

	Structure picture 150WQ150-35-37(I)	Manufacturer	CNP
		Address	Yuhang District, Hangzhou, Zhejiang,
Project Name		Contact	86-571-88637351
		Date	2022/03/09
Item NO		Client Name	DPA
		Client Addr.	
		Contacts	Alireza
		Contact	

CNP Nanfang Zhongjin Environment Co., Ltd.

	SECTIONAL DRAWING	No.	No.
TYPE	submersible sewage pump	MODEL	30/37KW

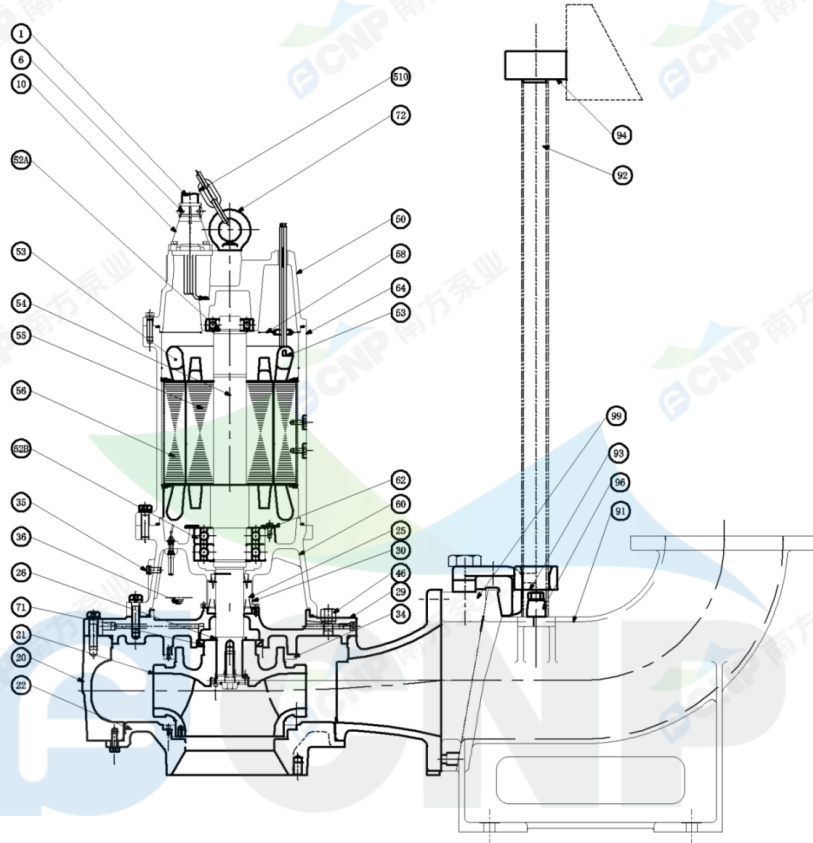

order specifications

No.	names of parts	number	material	No.	names of parts	number	material
1	cable	2	YCW	54	shaft	1	
6	cable sleeve	2	HT200	55	rotor	1	
50	top cover	1	HT200	56	stator	1	
58	cable transit board	1	Q235	52B	lower bearing	2	
64	base	1	HT200	36	machine oil 32#		
62	Bearing cover	1	HT200	26	framework oil seal	3	NBRI-2
25	mechanical seal	1	Carbon/SiC	35	oil filler plug	2	SUS304
30	oil lift	1		71	Shaft sleeve	2	1Cr13
60	lower cover	1	HT200	21	impeller	1	HT200
29	Casingtop cover	1	HT200	22	water inlet cover	1	HT200
20	casing	1	HT200	34	Neck ring	2	HT200
510	lift chain	1	SUS304	94	guiding	1	QT400
10	Cable lockblock	2	HT200	92	pipe	2	SUS304(unaffiliated)
72	eye bolt	2	45#(forging galvanized)	93	guide hook	1	QT500
52A	upper bearing	1		91	Discharge base	1	HT200
53	Mini-thermalprotector	1		99	Flange for coupling device	1	HT200
				96	Guiding fixing stopper	2	HT200

Nanfang Zhongjin Environment CO.,LTD.

unit: mm



Installation picture 150WQ150-35-37(I)

Manufacturer	CNP
Address	Yuhang District, Hangzhou, Zhejiang,
Contact	86-571-88637351
Date	2022/03/09
Client Name	DPA
Client Addr.	
Contacts	Alireza
Contact	

Project Name

Item NO

CNP Nanfang Zhongjin Environment Co., Ltd.

DIMENSION DRAWING		No.	No.
TYPE submersible sewage pump		MODEL	150WQ150-35-37

MODEL	d	A	A1	A2	A3	A4	A5	B	B1	D	D1	W1	W2	H	Body weight
WQ150-35-37	150	1015	1073	382	400	578	578	739	671	724	362	1250	1590	1580	698kg

elbow weight	19.0kg
bend weight	21kg

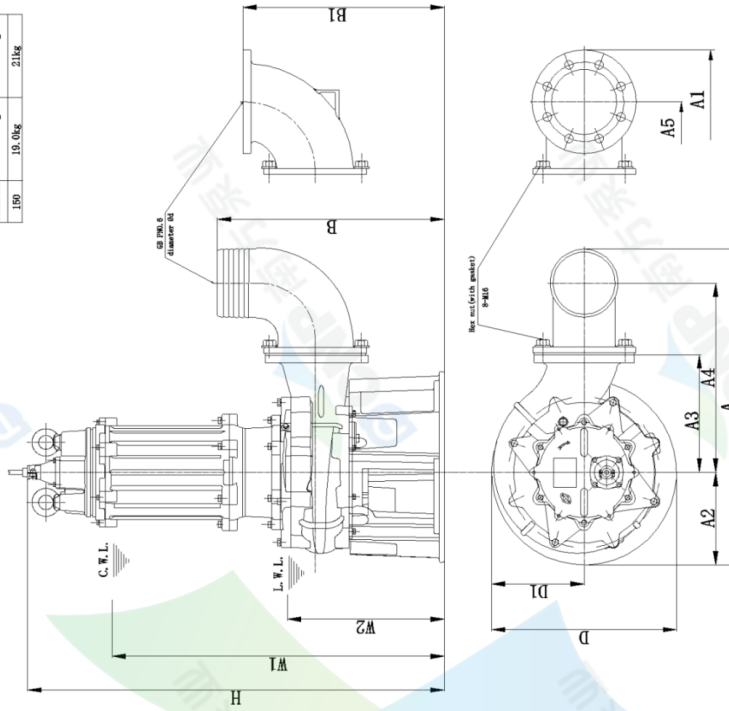

C.W.L.: minimum water level under continuous operation
L.W.L.: minimum water level under possible operation

Nanfang Zhongjin Environment Co., LTD. unit: mm

CNP Nanfang Zhongjin Environment Co., Ltd.

DIMENSION DRAWING		No.	No.
TYPE submersible sewage pump		MODEL	150WQ150-35-37

MODEL	A	A1	A2	A3	A4	D	D1	W1	W2	H	H1	H2	Body weight																																																																																																																																																																																																																																																																																																																																																																																																																																																																																																																																																																																																																																																																																																																																																																																																																																																																																																																																																																																																																																						
150WQ150-35-37	295	678	190	330	578	812	320	951	401	1399	2390	121	598kg																																																																																																																																																																																																																																																																																																																																																																																																																																																																																																																																																																																																																																																																																																																																																																																																																																																																																																																																																																																																																																						
Outlet diameter	d	T1	T2	T3	T4	T5	T6	T7	T8	T9	T10	K1	K2	K3	K4	K5	K6	K7	K8	K9	K10	K11	K12	K13	K14	K15	K16	K17	K18	K19	K20	K21	K22	K23	K24	K25	K26	K27	K28	K29	K30	K31	K32	K33	K34	K35	K36	K37	K38	K39	K40	K41	K42	K43	K44	K45	K46	K47	K48	K49	K50	K51	K52	K53	K54	K55	K56	K57	K58	K59	K60	K61	K62	K63	K64	K65	K66	K67	K68	K69	K70	K71	K72	K73	K74	K75	K76	K77	K78	K79	K80	K81	K82	K83	K84	K85	K86	K87	K88	K89	K90	K91	K92	K93	K94	K95	K96	K97	K98	K99	K100	K101	K102	K103	K104	K105	K106	K107	K108	K109	K110	K111	K112	K113	K114	K115	K116	K117	K118	K119	K120	K121	K122	K123	K124	K125	K126	K127	K128	K129	K130	K131	K132	K133	K134	K135	K136	K137	K138	K139	K140	K141	K142	K143	K144	K145	K146	K147	K148	K149	K150	K151	K152	K153	K154	K155	K156	K157	K158	K159	K160	K161	K162	K163	K164	K165	K166	K167	K168	K169	K170	K171	K172	K173	K174	K175	K176	K177	K178	K179	K180	K181	K182	K183	K184	K185	K186	K187	K188	K189	K190	K191	K192	K193	K194	K195	K196	K197	K198	K199	K200	K201	K202	K203	K204	K205	K206	K207	K208	K209	K210	K211	K212	K213	K214	K215	K216	K217	K218	K219	K220	K221	K222	K223	K224	K225	K226	K227	K228	K229	K230	K231	K232	K233	K234	K235	K236	K237	K238	K239	K240	K241	K242	K243	K244	K245	K246	K247	K248	K249	K250	K251	K252	K253	K254	K255	K256	K257	K258	K259	K260	K261	K262	K263	K264	K265	K266	K267	K268	K269	K270	K271	K272	K273	K274	K275	K276	K277	K278	K279	K280	K281	K282	K283	K284	K285	K286	K287	K288	K289	K290	K291	K292	K293	K294	K295	K296	K297	K298	K299	K300	K301	K302	K303	K304	K305	K306	K307	K308	K309	K310	K311	K312	K313	K314	K315	K316	K317	K318	K319	K320	K321	K322	K323	K324	K325	K326	K327	K328	K329	K330	K331	K332	K333	K334	K335	K336	K337	K338	K339	K340	K341	K342	K343	K344	K345	K346	K347	K348	K349	K350	K351	K352	K353	K354	K355	K356	K357	K358	K359	K360	K361	K362	K363	K364	K365	K366	K367	K368	K369	K370	K371	K372	K373	K374	K375	K376	K377	K378	K379	K380	K381	K382	K383	K384	K385	K386	K387	K388	K389	K390	K391	K392	K393	K394	K395	K396	K397	K398	K399	K400	K401	K402	K403	K404	K405	K406	K407	K408	K409	K410	K411	K412	K413	K414	K415	K416	K417	K418	K419	K420	K421	K422	K423	K424	K425	K426	K427	K428	K429	K430	K431	K432	K433	K434	K435	K436	K437	K438	K439	K440	K441	K442	K443	K444	K445	K446	K447	K448	K449	K450	K451	K452	K453	K454	K455	K456	K457	K458	K459	K460	K461	K462	K463	K464	K465	K466	K467	K468	K469	K470	K471	K472	K473	K474	K475	K476	K477	K478	K479	K480	K481	K482	K483	K484	K485	K486	K487	K488	K489	K490	K491	K492	K493	K494	K495	K496	K497	K498	K499	K500	K501	K502	K503	K504	K505	K506	K507	K508	K509	K510	K511	K512	K513	K514	K515	K516	K517	K518	K519	K520	K521	K522	K523	K524	K525	K526	K527	K528	K529	K530	K531	K532	K533	K534	K535	K536	K537	K538	K539	K540	K541	K542	K543	K544	K545	K546	K547	K548	K549	K550	K551	K552	K553	K554	K555	K556	K557	K558	K559	K560	K561	K562	K563	K564	K565	K566	K567	K568	K569	K570	K571	K572	K573	K574	K575	K576	K577	K578	K579	K580	K581	K582	K583	K584	K585	K586	K587	K588	K589	K590	K591	K592	K593	K594	K595	K596	K597	K598	K599	K600	K601	K602	K603	K604	K605	K606	K607	K608	K609	K610	K611	K612	K613	K614	K615	K616	K617	K618	K619	K620	K621	K622	K623	K624	K625	K626	K627	K628	K629	K630	K631	K632	K633	K634	K635	K636	K637	K638	K639	K640	K641	K642	K643	K644	K645	K646	K647	K648	K649	K650	K651	K652	K653	K654	K655	K656	K657	K658	K659	K660	K661	K662	K663	K664	K665	K666	K667	K668	K669	K670	K671	K672	K673	K674	K675	K676	K677	K678	K679	K680	K681	K682	K683	K684	K685	K686	K687	K688	K689	K690	K691	K692	K693	K694	K695	K696	K697	K698	K699	K700	K701	K702	K703	K704	K705	K706	K707	K708	K709	K710	K711	K712	K713	K714	K715	K716	K717	K718	K719	K720	K721	K722	K723	K724	K725	K726	K727	K728	K729	K730	K731	K732	K733	K734	K735	K736	K737	K738	K739	K740	K741	K742	K743	K744	K745	K746	K747	K748	K749	K750	K751	K752	K753	K754	K755	K756	K757	K758	K759	K760	K761	K762	K763	K764	K765	K766	K767	K768	K769	K770	K771	K772	K773	K774	K775	K776	K777	K778	K779	K780	K781	K782	K783	K784	K785	K786	K787	K788	K789	K790	K791	K792	K793	K794	K795	K796	K797	K798	K799	K800	K801	K802	K803	K804	K805	K806	K807	K808	K809	K810	K811	K812	K813	K814	K815	K816	K817	K818	K819	K820	K821	K822	K823	K824	K825	K826	K827	K828	K829	K830	K831	K832	K833	K834	K835	K836	K837	K838	K839	K840	K841	K842	K843	K844	K845	K846	K847	K848	K849	K850	K851	K852	K853	K854	K855	K856	K857	K858	K859	K860	K861	K862	K863	K864	K865	K866	K867	K868	K869	K870	K871	K872	K873	K874	K875	K876	K877	K878	K879	K880	K881	K882	K883	K884	K885	K886	K887	K888	K889	K890	K891	K892	K893	K894	K895	K896	K897	K898	K899	K900	K901	K902	K903	K904	K905	K906	K907	K908	K909	K910	K911	K912	K913	K914	K915	K916	K917	K918	K919	K920	K921	K922	K923	K924	K925	K926	K927	K928	K929	K930	K931	K932	K933	K934	K935	K936	K937	K938	K939	K940	K941	K942	K943	K944	K945	K946	K947	K948	K949	K950	K951	K952	K953	K954	K955	K956	K957	K958	K959	K960	K961	K962	K963	K964	K965	K966	K967	K968	K969	K970	K971	K972	K973	K974	K975	K976	K977	K978	K979	K980	K981	K982	K983	K984	K985	K986	K987	K988	K989	K990	K991	K992	K993	K994	K995	K996	K997	K998	K999	K1000

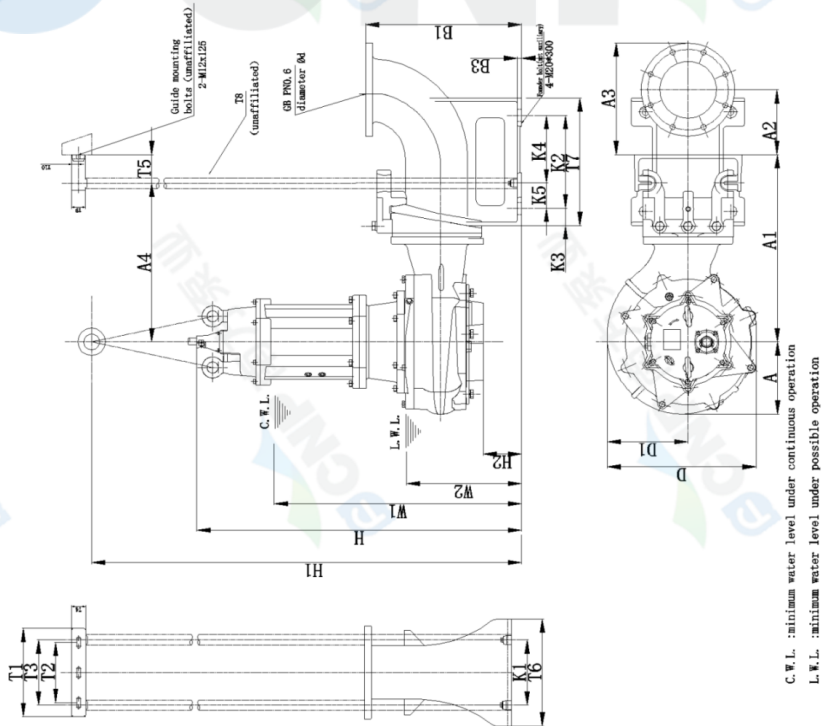

C.W.L.: minimum water level under continuous operation
L.W.L.: minimum water level under possible operation

Nanfang Zhongjin Environment Co., LTD. unit: mm