	Product Information CM4-5	Manufacturer	CNP
		Address	Yuhang District, Hangzhou, Zhejiang,
Project Name		Contact	86-571-88637351
		Date	2022/03/07
		Client Name	DPA
Item NO		Client Addr.	
		Contacts	Alireza
		Contact	

Part NO.	1100135454
----------	------------

Product Picture	Note
	<p>CM series are non-self-priming light horizontal multistage centrifugal pump with long shaft motor, compact structure, smaller size, axial inlet and radial outlet. Most parts adopt stamping technology. It's energy saving, environmental friendly, with beautiful appearance, light weight, low noise, convenient installation and maintenance, and high reliability.</p>

technology	
Pump rotator speed	2900
Material	
Impeller	304
Rubber code	P
Material Code	S
Installation	
Connection Code	L
Installation type	horizontal
Maximum Operation Pressure	10Bar
Medium	
Medium Temperature normal	-15+70
Medium Temperature high t	-15+105
Maximum Environment Temper	40
Structure dimension	
Inlet & outlet size types	G
Inlet & Outlet Diameter	G1/G1¼
Rotation Direction	Clockwise
Motor	
Number of Motor Phase	Three Phase
Protection Class	IP55
Insulation Class	F
Motor Power	1.1
Energy Efficiency Level	IE2
Seal	
Mechanical Seal	CM-16/B1SF4
Others	
Weight (kg)	13

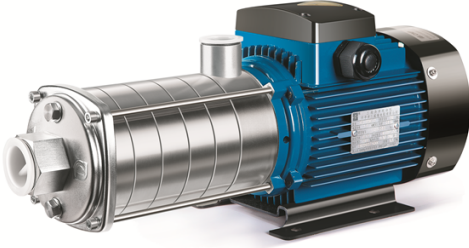

Performance Curve CM4-5

Manufacturer	CNP
Address	Yuhang District, Hangzhou, Zhejiang,
Contact	86-571-88637351
Date	2022/03/07
Client Name	DPA
Client Addr.	
Contacts	Alireza
Contact	

Project Name

Item NO

The hydraulic performance curve have been tested with Clean Water at 20°C, density 1000kg/m³, and at 1bar atmospheric pressure. ISO99062012 Grade 3B

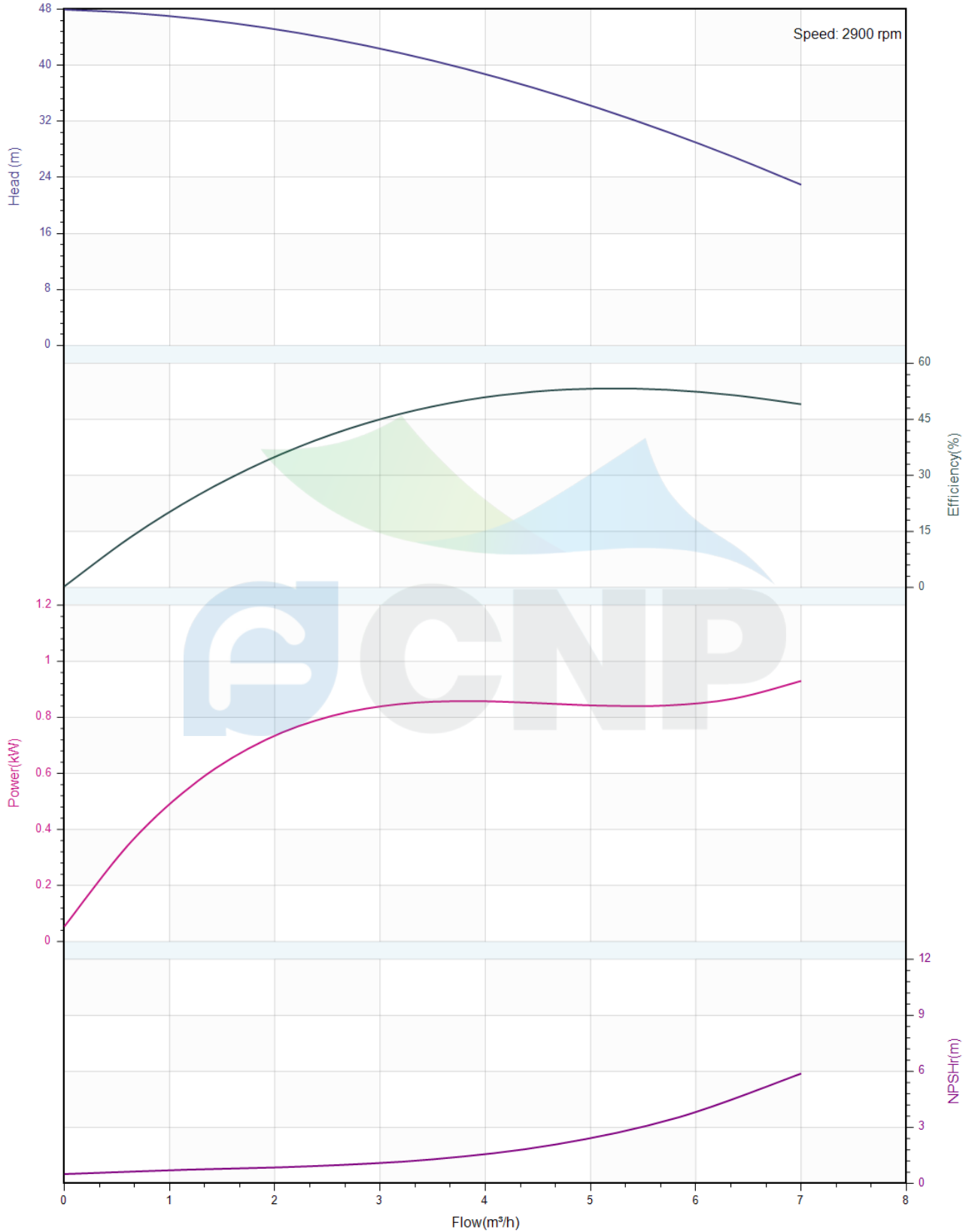



Pump Technical Parameters CM4-5

Manufacturer	CNP
Address	Yuhang District, Hangzhou, Zhejiang,
Contact	86-571-88637351
Date	2022/03/07
Client Name	DPA
Client Addr.	
Contacts	Alireza
Contact	

Rated parameters

Pump model	CM4-5
Part NO.	1100135454
Rated flow (m ³ /h)	4
Rated head (m)	39
Rated efficiency (%)	49
Power (kW)	0.87
NPSHr (m)	2
Speed (rpm)	2900
Max impeller diameter (mm)	95

Medium

Pumped medium	Clean Water
Working temperature (°C)	20
Medium density (kg/m ³)	1000
Viscosity (mm ² /s)	1

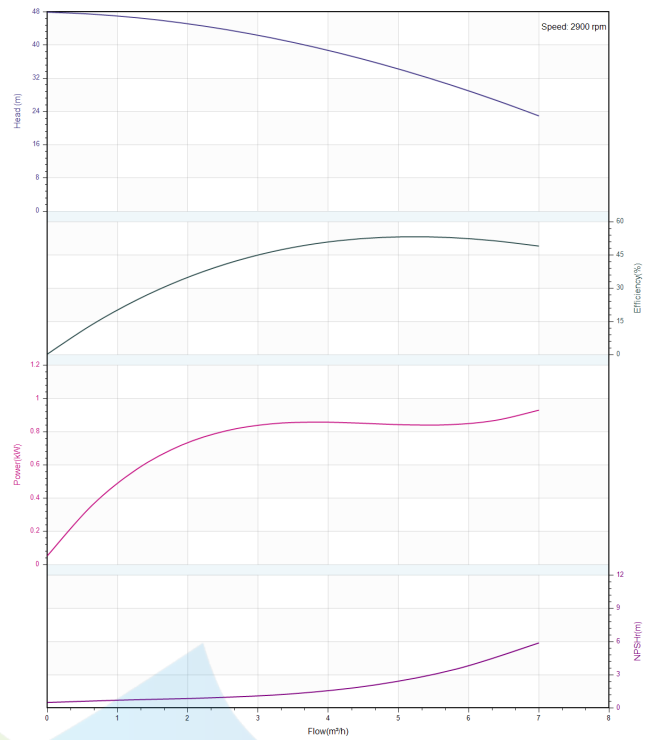

	Structure picture CM4-5	Manufacturer	CNP
		Address	Yuhang District, Hangzhou, Zhejiang,
Project Name		Contact	86-571-88637351
		Date	2022/03/07
		Client Name	DPA
Item NO		Client Addr.	
		Contacts	Alireza
		Contact	



图1: E-CM2、
4-190101



Dimension Drawing CM4-5

Manufacturer	CNP
Address	Yuhang District, Hangzhou, Zhejiang,
Contact	86-571-88637351
Date	2022/03/07
Client Name	DPA
Client Addr.	
Contacts	Alireza
Contact	

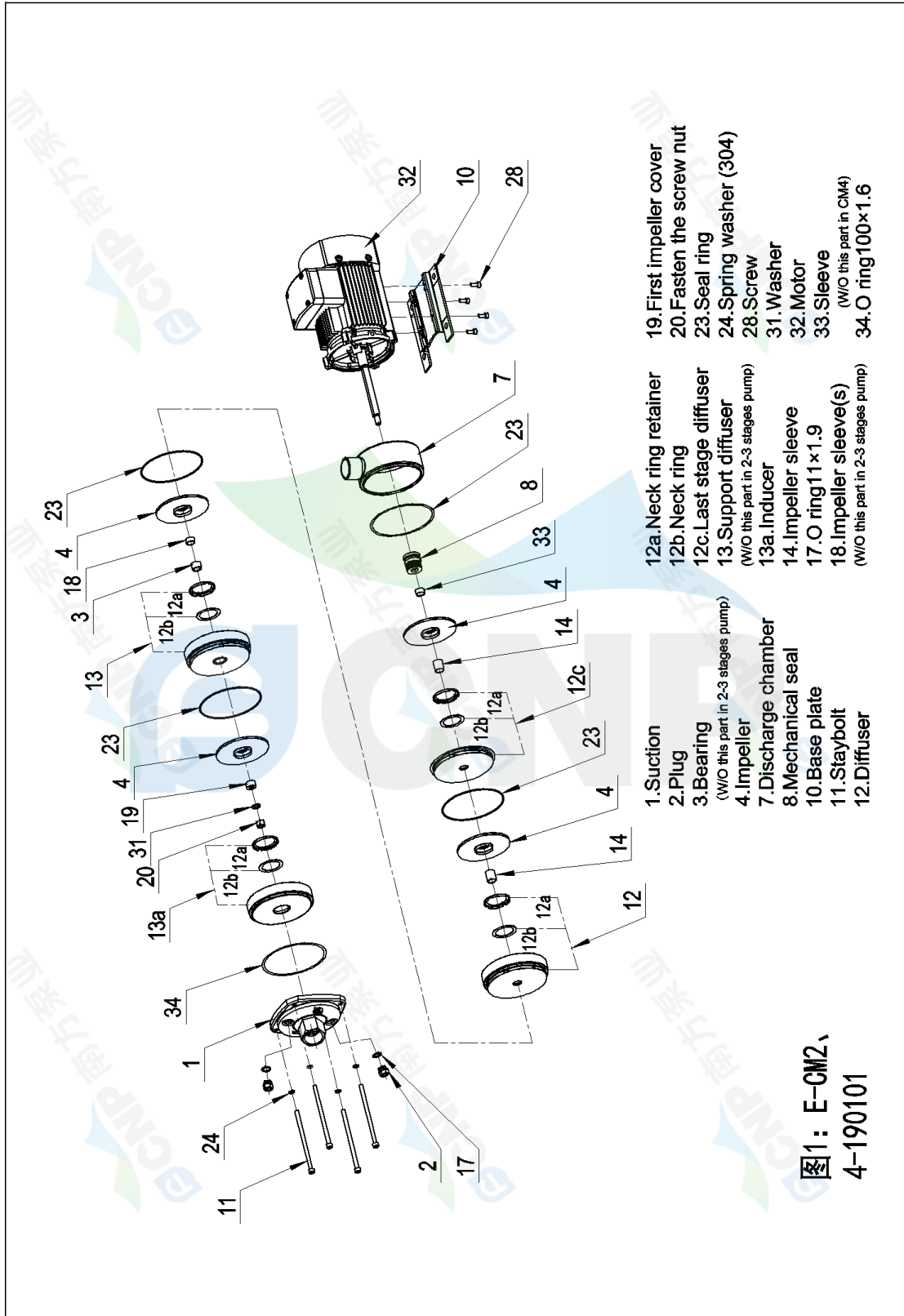
Project Name

Item NO

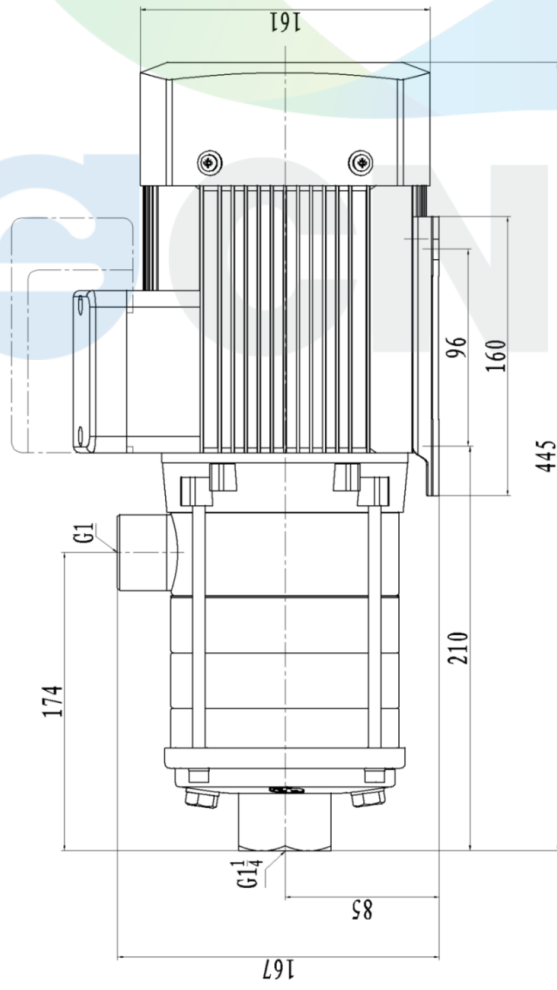
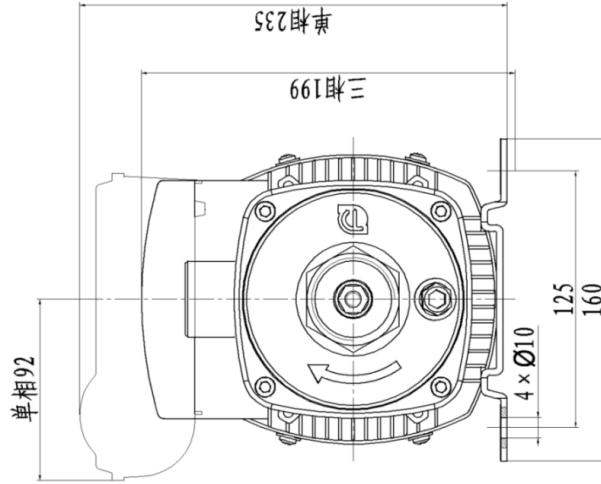

CM4-5