

| | | | |
|--|--|--------------|--------------------------------------|
|  | Product Information CM2-3 | Manufacturer | CNP |
| | | Address | Yuhang District, Hangzhou, Zhejiang, |
| Project Name | | Contact | 86-571-88637351 |
| | | Date | 2022/03/07 |
| Item NO | | Client Name | DPA |
| | | Client Addr. | |
| | | Contacts | Alireza |
| | | Contact | |

| | |
|----------|------------|
| Part NO. | 1100135447 |
|----------|------------|

| Product Picture | Note |
|---|--|
|  | <p>CM series are non-self-priming light horizontal multistage centrifugal pump with long shaft motor, compact structure, smaller size, axial inlet and radial outlet. Most parts adopt stamping technology. It's energy saving, environmental friendly, with beautiful appearance, light weight, low noise, convenient installation and maintenance, and high reliability.</p> |

| | |
|----------------------------|-------------|
| technology | |
| Pump rotator speed | 2900 |
| Material | |
| Impeller | 304 |
| Rubber code | P |
| Material Code | S |
| Installation | |
| Connection Code | L |
| Installation type | horizontal |
| Maximum Operation Pressure | 10Bar |
| Medium | |
| Medium Temperature normal | -15+70 |
| Medium Temperature high t | -15+105 |
| Maximum Environment Temper | 40 |
| Structure dimension | |
| Inlet & outlet size types | G |
| Inlet & Outlet Diameter | G1 |
| Rotation Direction | Clockwise |
| Motor | |
| Number of Motor Phase | Three Phase |
| Protection Class | IP55 |
| Insulation Class | F |
| Motor Power | 0.37 |
| Energy Efficiency Level | IE2 |
| Seal | |
| Mechanical Seal | CM-16/B1SF4 |
| Others | |
| Weight (kg) | 7 |

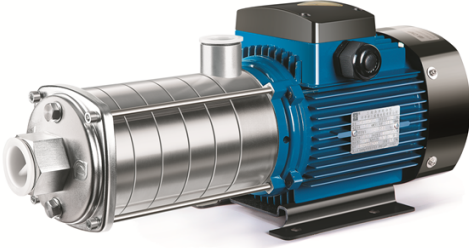

Performance Curve CM2-3

| | |
|--------------|--------------------------------------|
| Manufacturer | CNP |
| Address | Yuhang District, Hangzhou, Zhejiang, |
| Contact | 86-571-88637351 |
| Date | 2022/03/07 |
| Client Name | DPA |
| Client Addr. | |
| Contacts | Alireza |
| Contact | |

Project Name

Item NO

The hydraulic performance curve have been tested with Clean Water at 20°C, density 1000kg/m³, and at 1bar atmospheric pressure. ISO99062012 Grade 3B

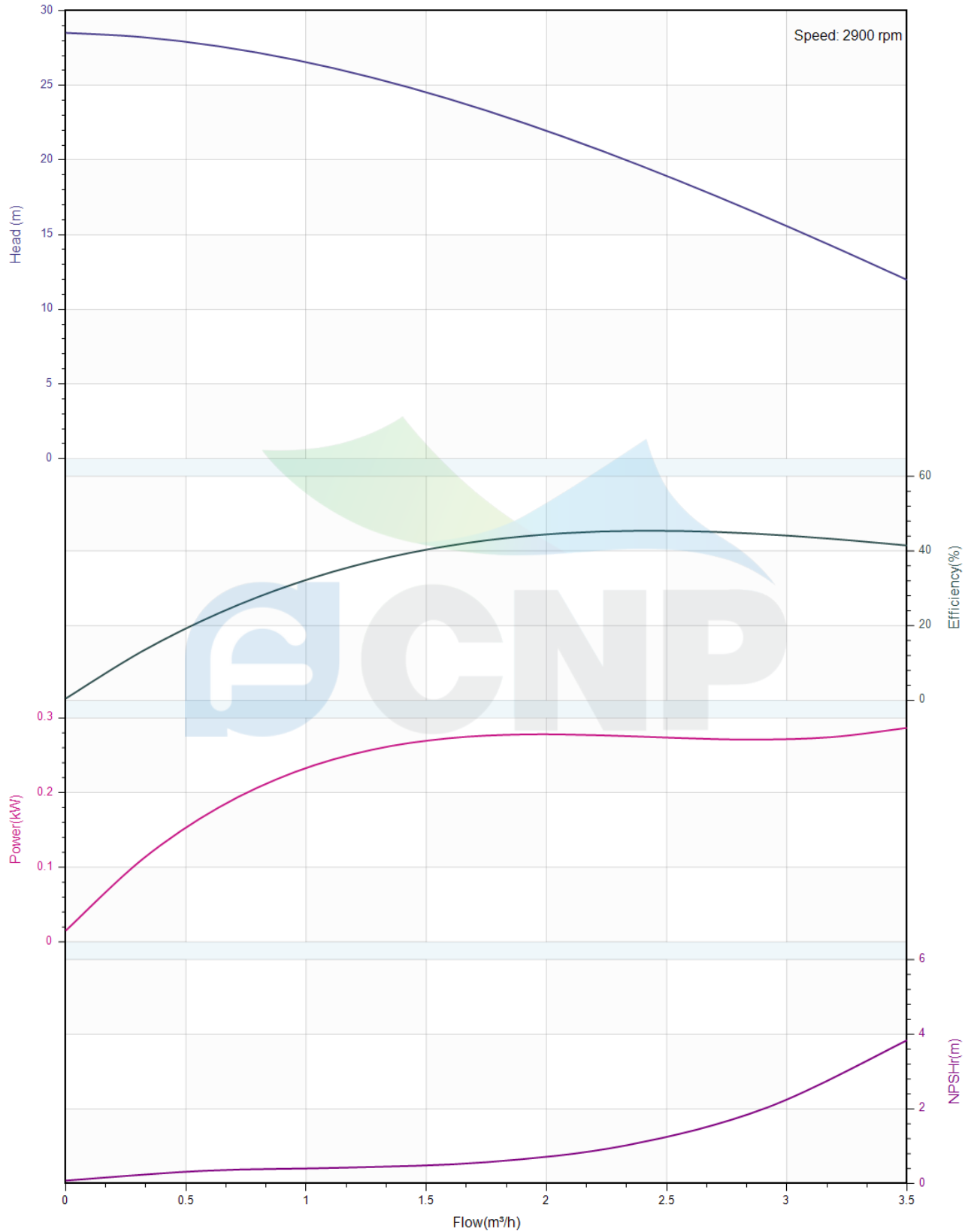



Pump Technical Parameters CM2-3

| | |
|--------------|--------------------------------------|
| Manufacturer | CNP |
| Address | Yuhang District, Hangzhou, Zhejiang, |
| Contact | 86-571-88637351 |
| Date | 2022/03/07 |
| Client Name | DPA |
| Client Addr. | |
| Contacts | Alireza |
| Contact | |

Rated parameters

| | |
|--------------------------------|------------|
| Pump model | CM2-3 |
| Part NO. | 1100135447 |
| Rated flow (m ³ /h) | 2 |
| Rated head (m) | 22 |
| Rated efficiency (%) | 41 |
| Power (kW) | 0.29 |
| NPSHr (m) | 2 |
| Speed (rpm) | 2900 |
| Max impeller diameter (mm) | 90 |

Medium

| | |
|-------------------------------------|-------------|
| Pumped medium | Clean Water |
| Working temperature (°C) | 20 |
| Medium density (kg/m ³) | 1000 |
| Viscosity (mm ² /s) | 1 |

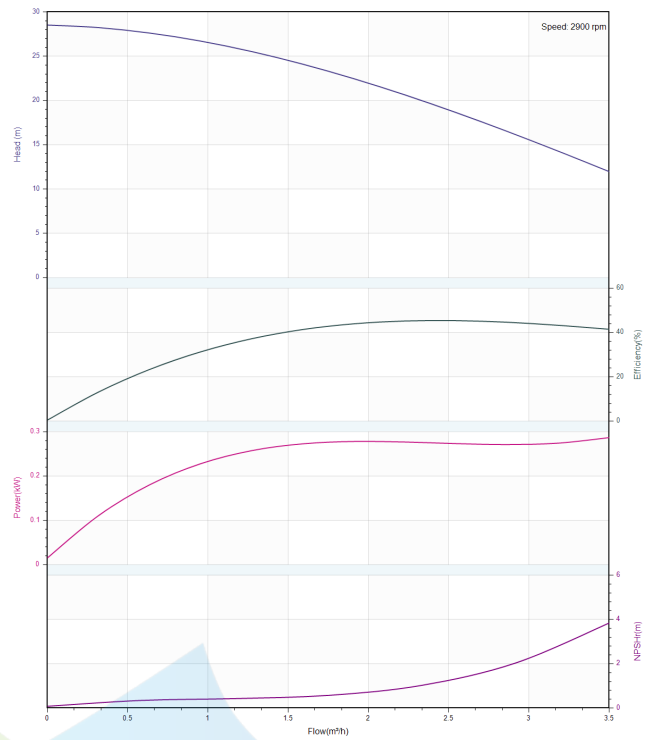

| | | | |
|--|--|--------------|--------------------------------------|
|  | Structure picture CM2-3 | Manufacturer | CNP |
| | | Address | Yuhang District, Hangzhou, Zhejiang, |
| Project Name | | Contact | 86-571-88637351 |
| | | Date | 2022/03/07 |
| Item NO | | Client Name | DPA |
| | | Client Addr. | |
| | | Contacts | Alireza |
| | | Contact | |

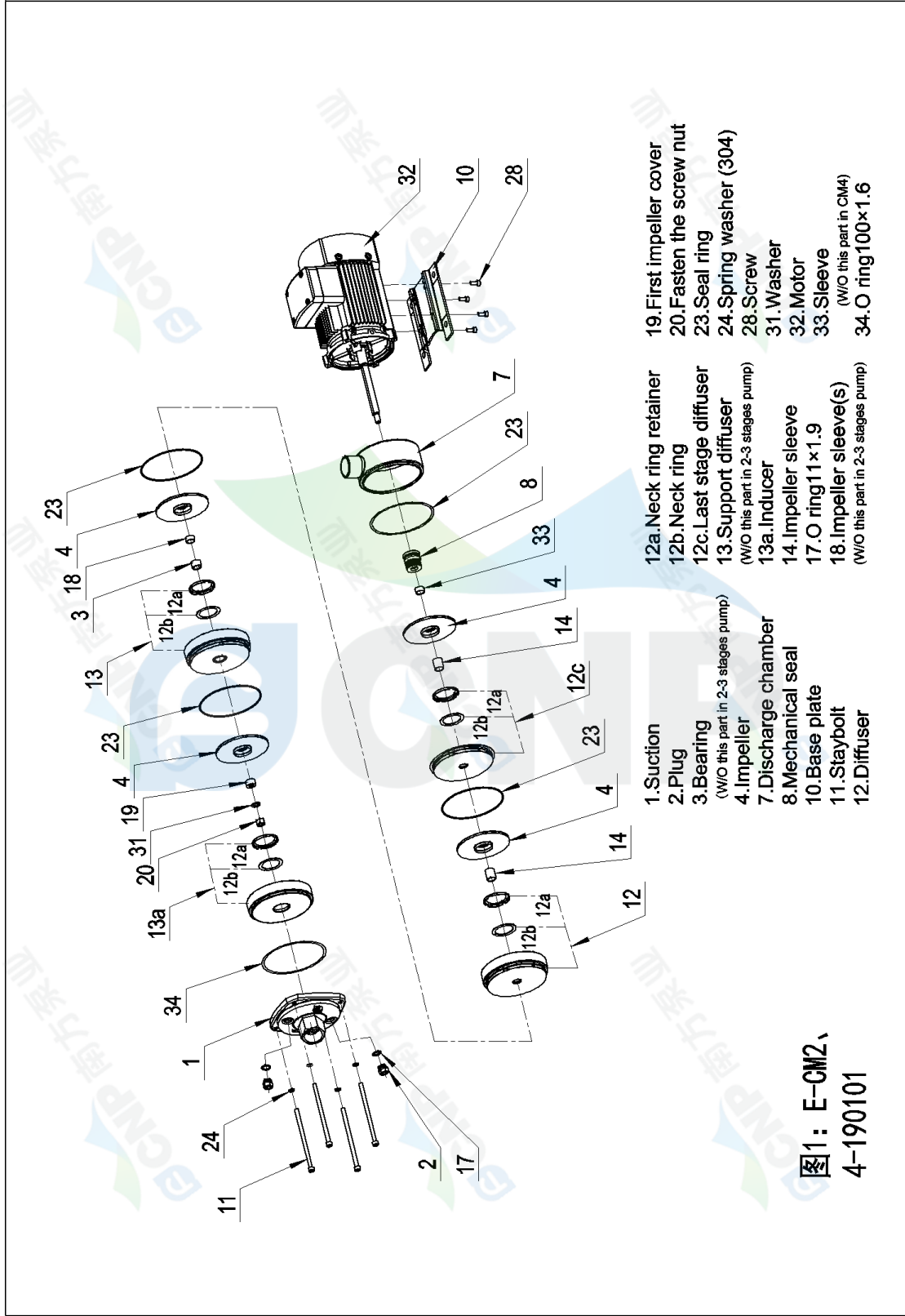

**图1: E-CM2、
4-190101**



Dimension Drawing CM2-3

| | |
|--------------|--------------------------------------|
| Manufacturer | CNP |
| Address | Yuhang District, Hangzhou, Zhejiang, |
| Contact | 86-571-88637351 |
| Date | 2022/03/07 |
| Client Name | DPA |
| Client Addr. | |
| Contacts | Alireza |
| Contact | |

Project Name

Item NO

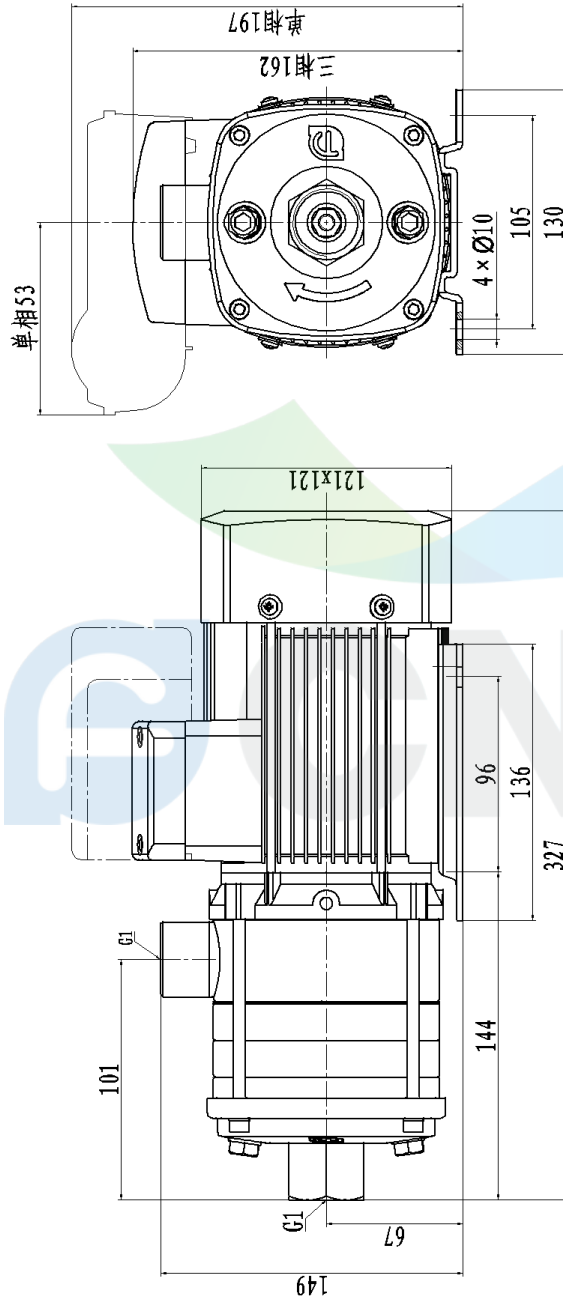

CM2-3