	<b>Product Information</b>  <b>CL4-5</b>	Manufacturer	CNP
		Address	Yuhang District, Hangzhou, Zhejiang,
<b>Project Name</b>		Contact	86-571-88637351
		Date	2022/03/07
		Client Name	DPA
<b>Item NO</b>		Client Addr.	
		Contacts	Alireza
		Contact	

Part NO.	1100154196
----------	------------

Product Picture	Note
	<p>CL series pump is non-self-priming light horizontal multistage centrifugal pump for chillers. It effectively solves the failure of mechanical seal dry friction caused by insufficient water intake, aiming at the condition of insufficient water intake. The compact structure makes for small pump size, with axial inlet and radial outlet. It's energy saving, environmental friendly, with beautiful appearance, light weight, low noise, convenient installation and maintenance, and high reliability.</p>

<b>technology</b>	
Pump rotator speed	2900
<b>Material</b>	
Impeller	304
Rubber code	P
Material Code	S
<b>Installation</b>	
Connection Code	L
Installation type	horizontal
Maximum Operation Pressure	10Bar
<b>Medium</b>	
Medium Temperature	-15+70
Maximum Environment Temper	40
<b>Structure dimension</b>	
Inlet & outlet size types	G
Inlet & Outlet Diameter	G1/G1?
Rotation Direction	Clockwise
<b>Motor</b>	
Number of Motor Phase	Three Phase
Protection Class	IP55
Insulation Class	F
Motor Power	1.1
Energy Efficiency Level	IE2
<b>Seal</b>	
Mechanical Seal	CM-16/BSF4
<b>Others</b>	
Weight (kg)	14

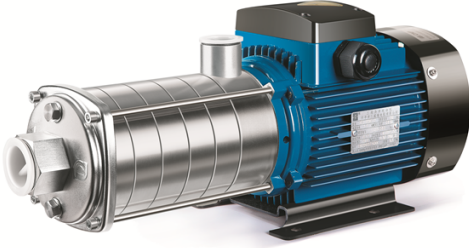

# Performance Curve CL4-5

Manufacturer	CNP
Address	Yuhang District, Hangzhou, Zhejiang,
Contact	86-571-88637351
Date	2022/03/07
Client Name	DPA
Client Addr.	
Contacts	Alireza
Contact	

Project Name

Item NO

The hydraulic performance curve have been tested with Clean Water at 20°C, density 1000kg/m<sup>3</sup>, and at 1bar atmospheric pressure. ISO99062012 Grade 3B

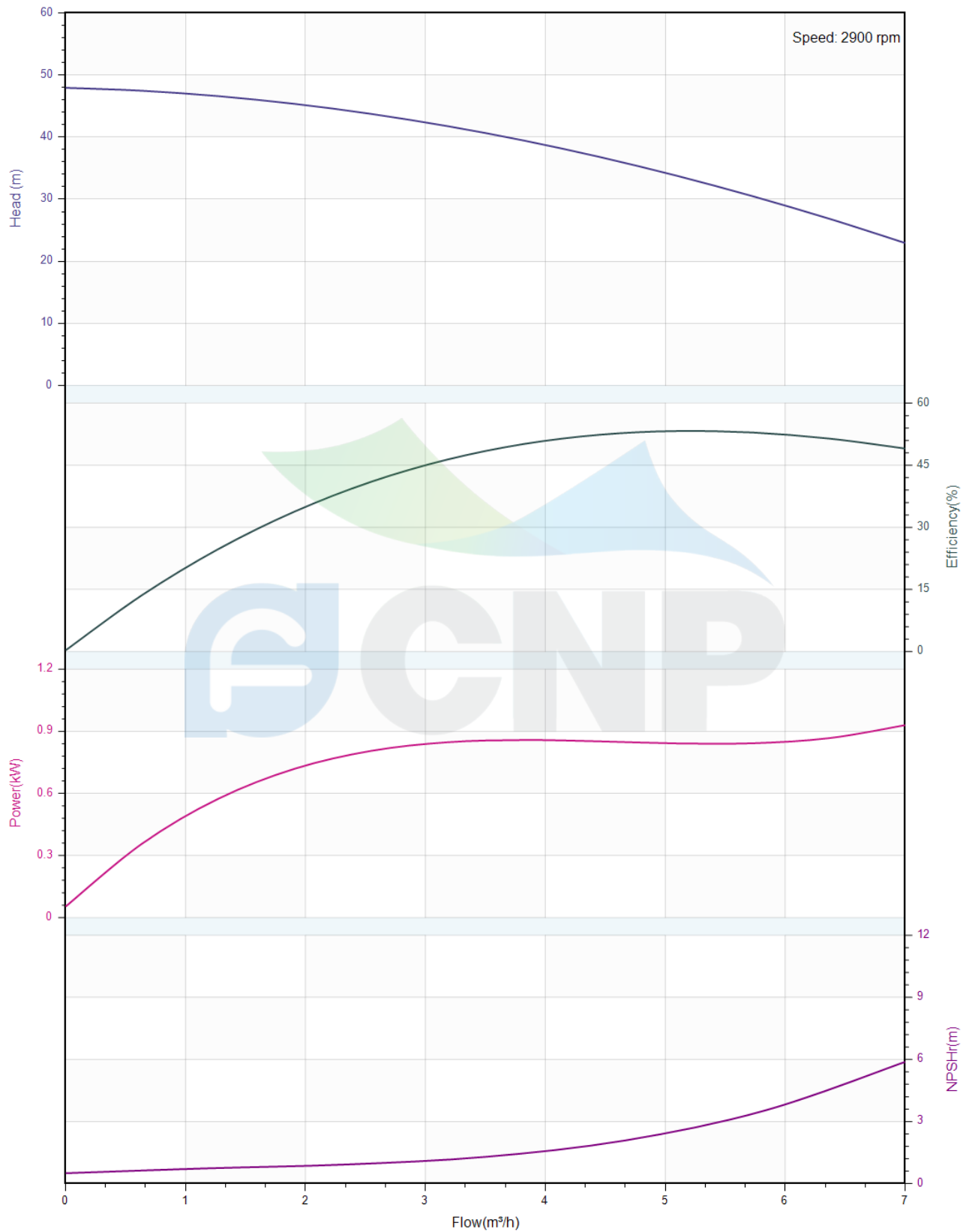



## Pump Technical Parameters CL4-5

Manufacturer	CNP
Address	Yuhang District, Hangzhou, Zhejiang,
Contact	86-571-88637351
Date	2022/03/07
Client Name	DPA
Client Addr.	
Contacts	Alireza
Contact	

### Rated parameters

Pump model	CL4-5
Part NO.	1100154196
Rated flow (m <sup>3</sup> /h)	4
Rated head (m)	39
Rated efficiency (%)	54
Power (kW)	0.787
NPSHr (m)	2
Speed (rpm)	2900
Max impeller diameter (mm)	95

### Medium

Pumped medium	Clean Water
Working temperature (°C)	20
Medium density (kg/m <sup>3</sup> )	1000
Viscosity (mm <sup>2</sup> /s)	1

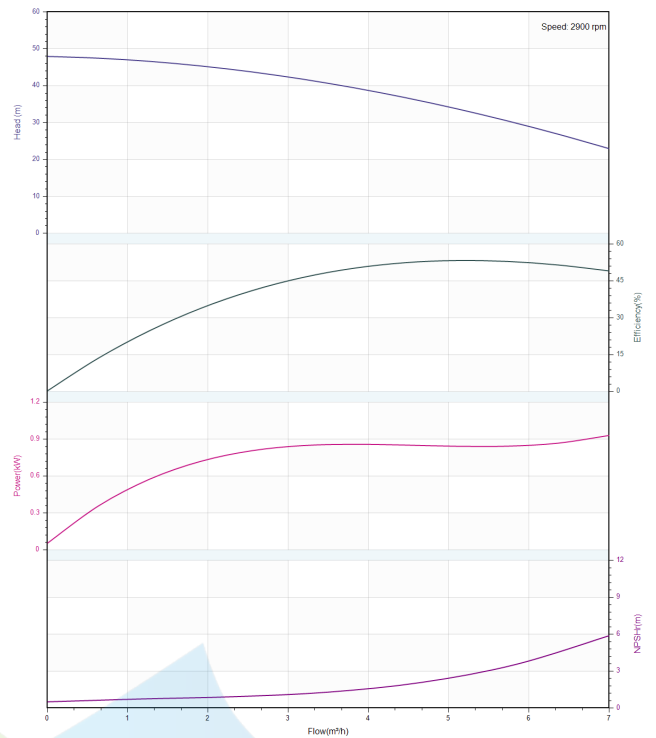

	<b>Structure picture</b> <b>CL4-5</b>	Manufacturer	CNP
		Address	Yuhang District, Hangzhou, Zhejiang,
Project Name		Contact	86-571-88637351
		Date	2022/03/07
		Client Name	DPA
Item NO		Client Addr.	
		Contacts	Alireza
		Contact	



图1: CL1、2、4-190601



### Dimension Drawing CL4-5

Manufacturer	CNP
Address	Yuhang District, Hangzhou, Zhejiang,
Contact	86-571-88637351
Date	2022/03/07
Client Name	DPA
Client Addr.	
Contacts	Alireza
Contact	

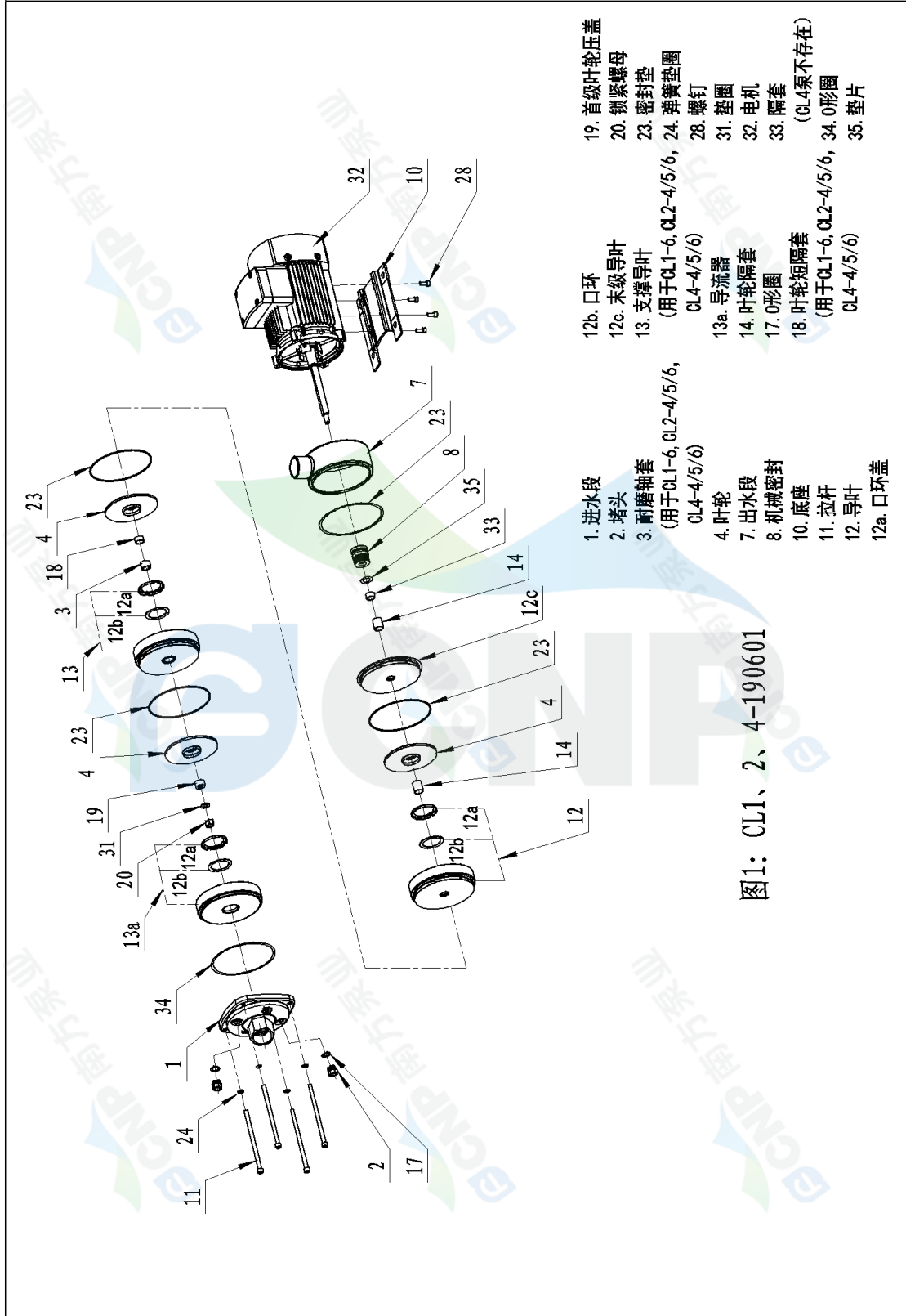
Project Name

Item NO

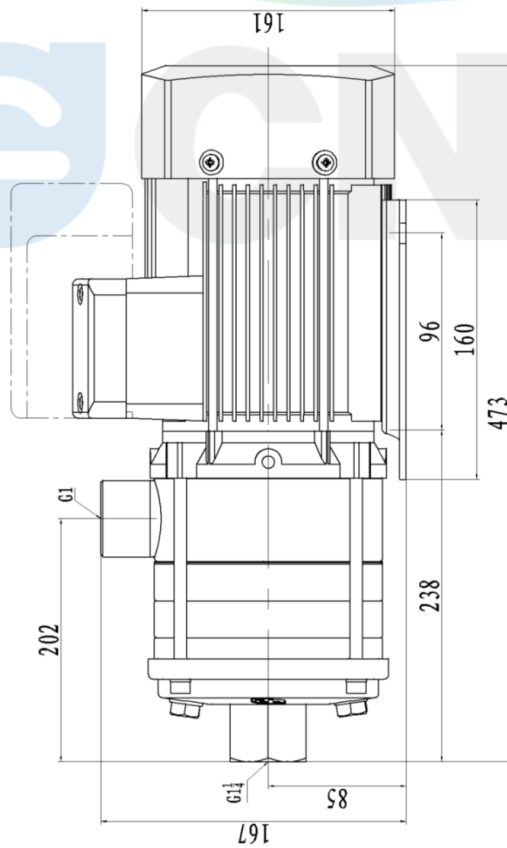
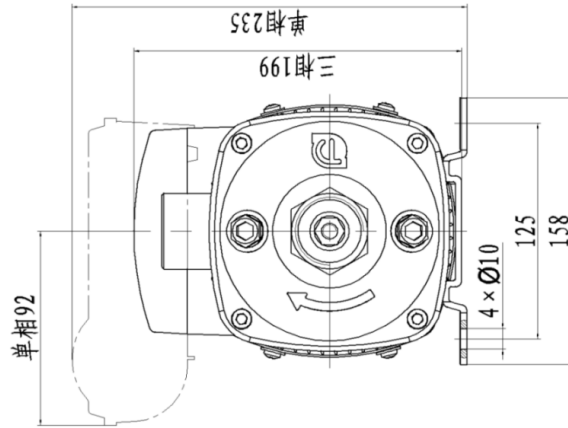

CL4-5