	<b>Product Information</b> <b>CHM5-30</b>	Manufacturer	CNP
		Address	Yuhang District, Hangzhou, Zhejiang,
Project Name		Contact	86-571-88637351
		Date	2022/03/07
Item NO		Client Name	DPA
		Client Addr.	
		Contacts	Alireza
		Contact	

Part NO.	1100178557
----------	------------

Product Picture	Note
	<p>Non-self-priming horizontal multistage centrifugal pump. The impeller guide vane is made of stainless steel plate stamping and welding. Equipped with long shaft motor, axial inlet and radial outlet.</p>

### technology

Pump rotator speed 2900

### Material

Impeller 304

Rubber code F

Material Code S

### Installation

Connection Code L

Installation type horizontal

Maximum Operation Pressure 10Bar

### Medium

Medium Temperature normal -15+70

Medium Temperature high t -15+105

Maximum Environment Temper 40

### Structure dimension

Inlet & outlet size types G

Inlet & Outlet Diameter G1½/G1

Rotation Direction Clockwise

### Motor

Number of Motor Phase Three Phase

Protection Class IP55

Insulation Class F

Motor Power 0.55

Energy Efficiency Level IE2

### Seal

Mechanical Seal CHM-14/SB1F4

### Others

Weight (kg) 10



### Performance Curve CHM5-30

Manufacturer	CNP
Address	Yuhang District, Hangzhou, Zhejiang,
Contact	86-571-88637351
Date	2022/03/07
Client Name	DPA
Client Addr.	
Contacts	Alireza
Contact	

Project Name

Item NO

The hydraulic performance curve have been tested with Clean Water at 20°C, density 1000kg/m<sup>3</sup>, and at 1bar atmospheric pressure. ISO99062012 Grade 3B

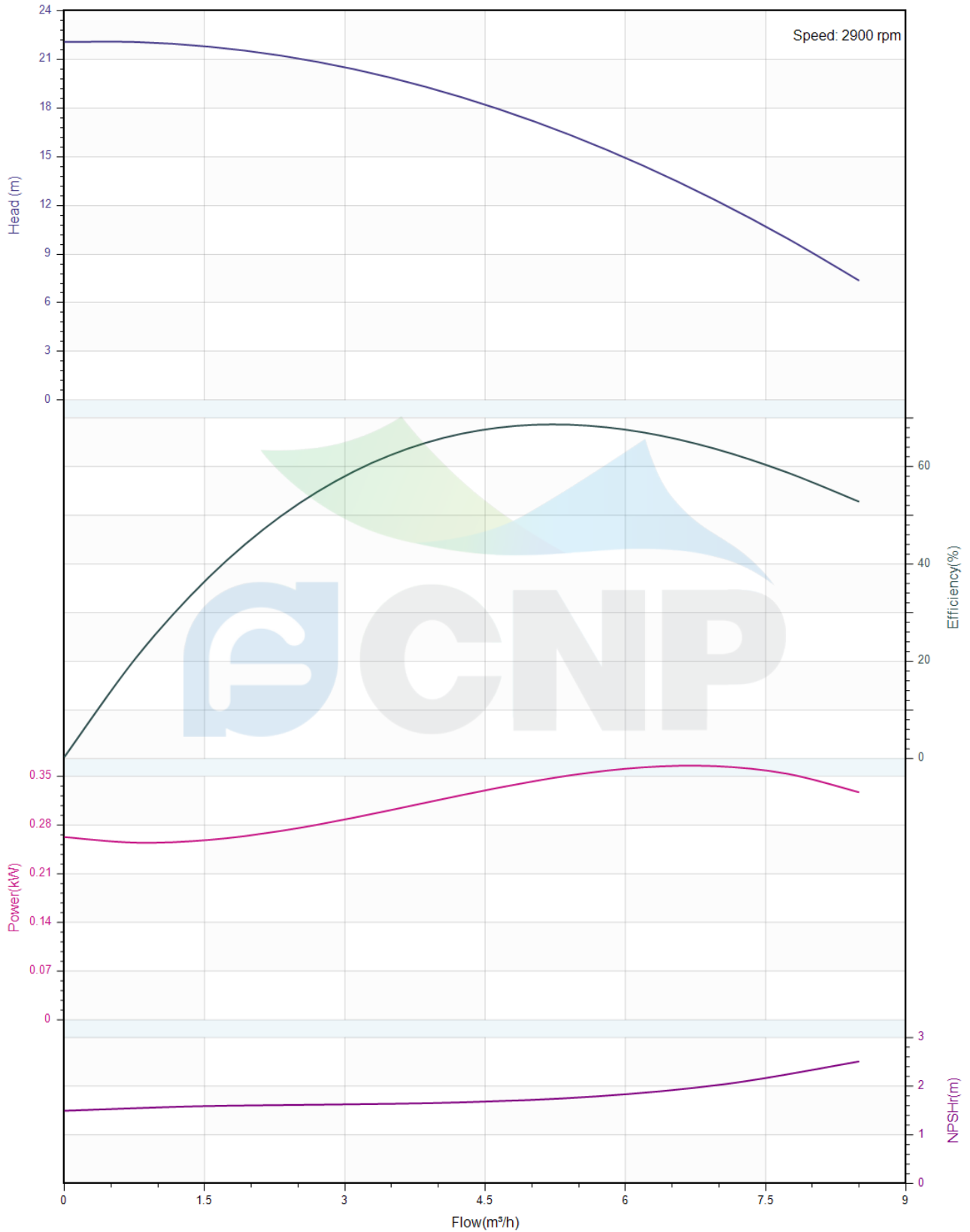



## Pump Technical Parameters CHM5-30

Manufacturer	CNP
Address	Yuhang District, Hangzhou, Zhejiang,
Contact	86-571-88637351
Date	2022/03/07
Client Name	DPA
Client Addr.	
Contacts	Alireza
Contact	

### Rated parameters

Pump model	CHM5-30
Part NO.	1100178557
Rated flow (m <sup>3</sup> /h)	5
Rated head (m)	17.5
Rated efficiency (%)	67
Power (kW)	0.356
NPSHr (m)	1.8
Speed (rpm)	2900
Max impeller diameter (mm)	82

### Medium

Pumped medium	Clean Water
Working temperature (°C)	20
Medium density (kg/m <sup>3</sup> )	1000
Viscosity (mm <sup>2</sup> /s)	1

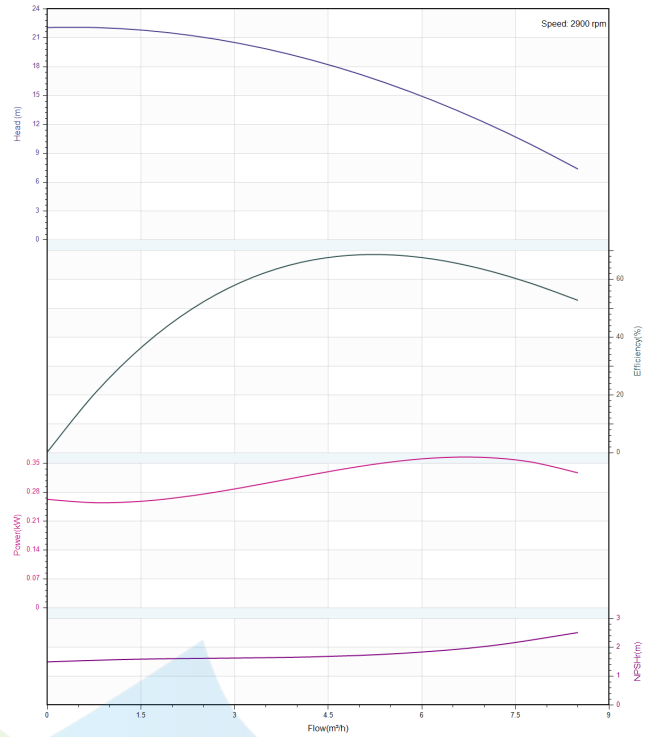

	<b>Structure picture</b> <b>CHM5-30</b>	Manufacturer	CNP
		Address	Yuhang District, Hangzhou, Zhejiang,
Project Name		Contact	86-571-88637351
		Date	2022/03/07
Item NO		Client Name	DPA
		Client Addr.	
		Contacts	Alireza
		Contact	

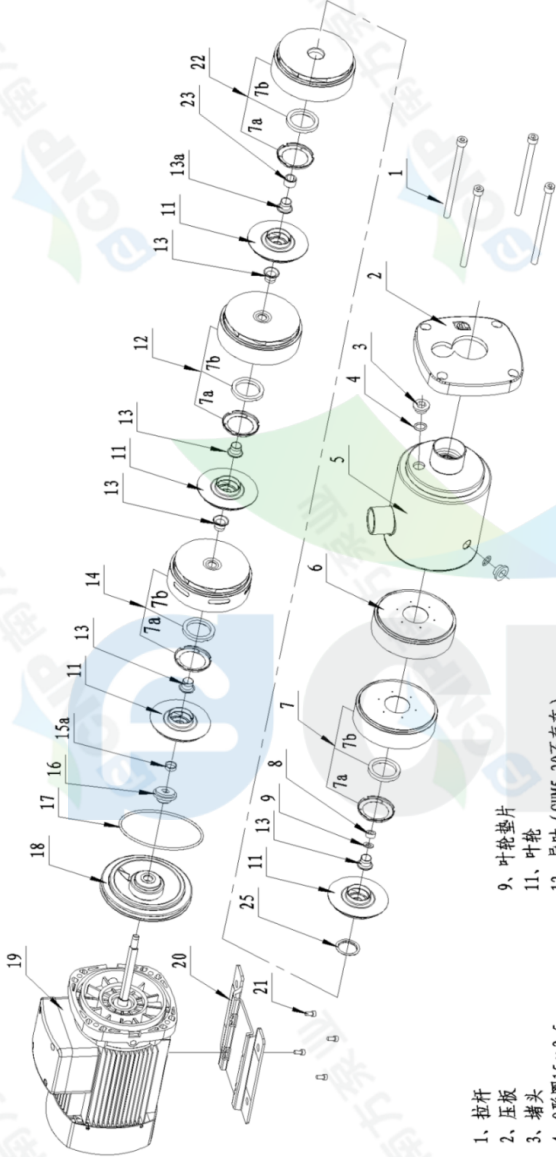

CHM5-200801



- 1、拉杆
- 2、压板
- 3、堵头
- 4、O形圈15×2.5
- 5、进出水段
- 6、导流壳体 (仅用于CHM5-30)
- 7、导流器
- 7a、口环盖
- 7b、口环
- 8、螺母M8
- 9、叶轮垫片
- 11、叶轮
- 12、导叶 (CHM5-20不存在)
- 13、叶轮隔套13×12.6
- 14、出水导叶
- 15a、出水叶轮隔套
- 16、机械密封
- 17、O形圈115×4
- 18、密封座
- 19、电机
- 20、底座
- 21、螺钉M5×12
- 22、支撑导叶 (仅用于CHM5-40至5-80)
- 23、耐磨轴套 (仅用于CHM5-40至5-80)
- 25、支撑垫片 (仅用于CHM5-40至5-80)

新一代CHM5-200801

插图
修改
旧版图号
新版图号
签字
日期

		<b>爆炸图</b>	
		图样标记	比例
设计	校对	S	1:1
审核	工艺		
日期	日期		
		<b>轻型卧式多级离心泵</b>	
		<b>CHM5-200801</b>	
共 1 页	第 1 页		



### Dimension Drawing CHM5-30

Manufacturer	CNP
Address	Yuhang District, Hangzhou, Zhejiang,
Contact	86-571-88637351
Date	2022/03/07
Client Name	DPA
Client Addr.	
Contacts	Alireza
Contact	

Project Name

Item NO

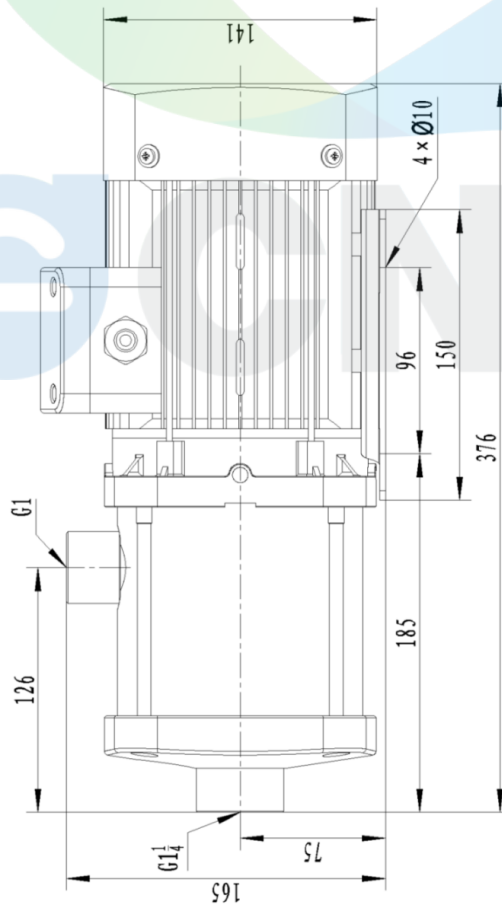
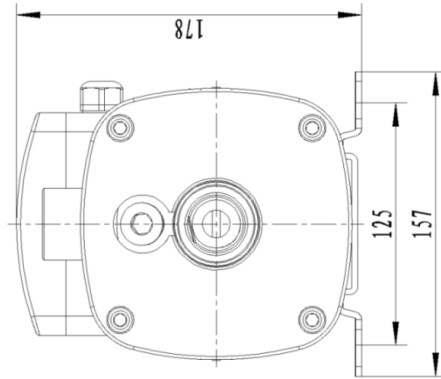

CHM5-30 50HZ