	<b>Product Information</b>  <b>CHM3-80</b>	Manufacturer	CNP
		Address	Yuhang District, Hangzhou, Zhejiang,
Project Name		Contact	86-571-88637351
		Date	2022/03/07
Item NO		Client Name	DPA
		Client Addr.	
		Contacts	Alireza
		Contact	

Part NO.	1100178554
----------	------------

Product Picture	Note
	<p>Non-self-priming horizontal multistage centrifugal pump. The impeller guide vane is made of stainless steel plate stamping and welding. Equipped with long shaft motor, axial inlet and radial outlet.</p>

<b>technology</b>	
Pump rotator speed	2900
<b>Material</b>	
Impeller	304
Rubber code	F
Material Code	S
<b>Installation</b>	
Connection Code	L
Installation type	horizontal
Maximum Operation Pressure	10Bar
<b>Medium</b>	
Medium Temperature normal	-15+70
Medium Temperature high t	-15+105
Maximum Environment Temper	40
<b>Structure dimension</b>	
Inlet & outlet size types	G
Inlet & Outlet Diameter	G1
Rotation Direction	Clockwise
<b>Motor</b>	
Number of Motor Phase	Three Phase
Protection Class	IP55
Insulation Class	F
Motor Power	0.75
Energy Efficiency Level	IE2
<b>Seal</b>	
Mechanical Seal	CHM-14/SB1F4
<b>Others</b>	
Weight (kg)	15





# Performance Curve CHM3-80

Manufacturer	CNP
Address	Yuhang District, Hangzhou, Zhejiang,
Contact	86-571-88637351
Date	2022/03/07
Client Name	DPA
Client Addr.	
Contacts	Alireza
Contact	

Project Name	
Item NO	

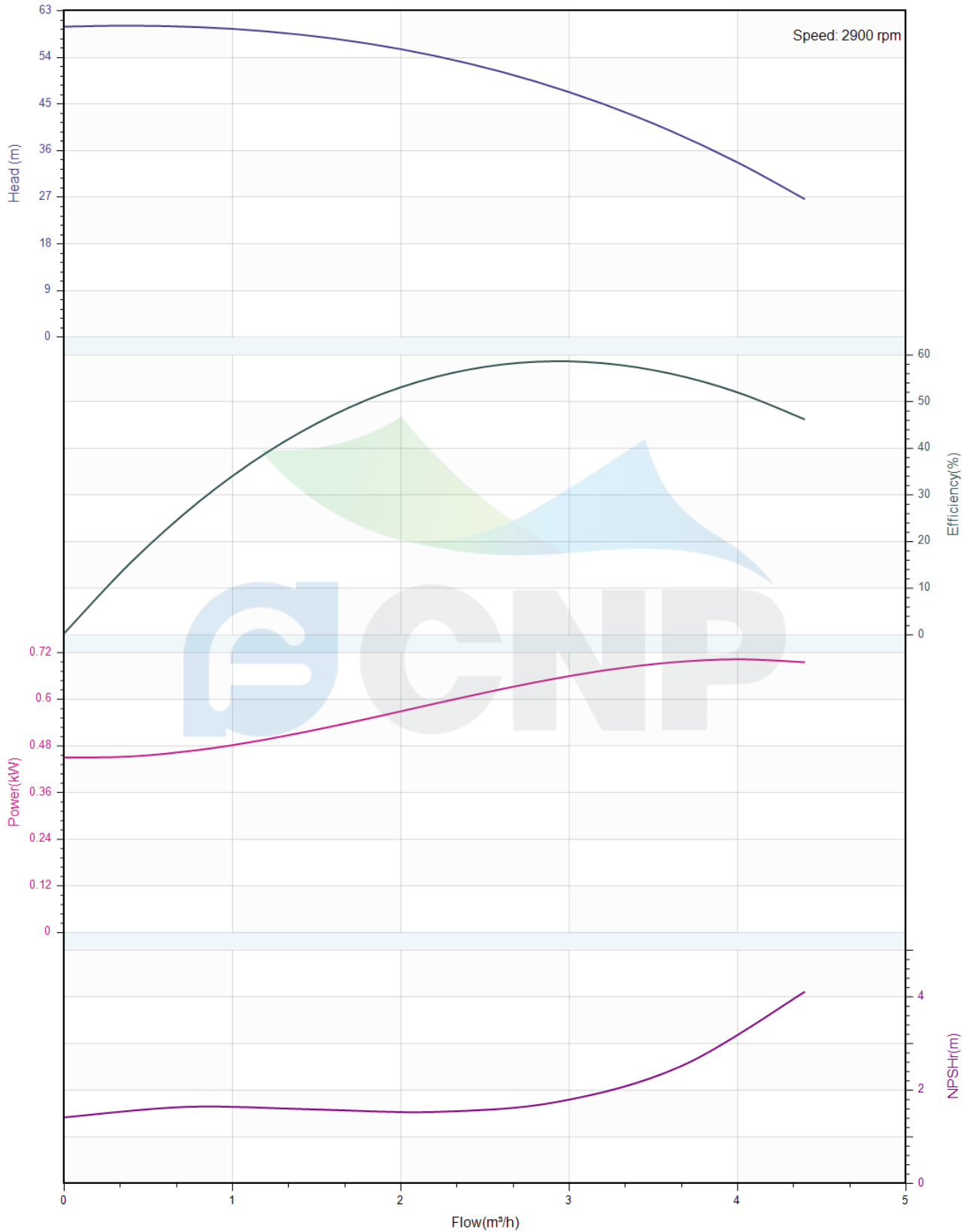
The hydraulic performance curve have been tested with Clean Water at 20°C, density 1000kg/m<sup>3</sup>, and at 1bar atmospheric pressure. ISO99062012 Grade 3B



	<b>Pump Technical Parameters</b> <b>CHM3-80</b>	Manufacturer	CNP
		Address	Yuhang District, Hangzhou, Zhejiang,
Project Name		Contact	86-571-88637351
		Date	2022/03/07
Item NO		Client Name	DPA
		Client Addr.	
		Contacts	Alireza
		Contact	

Rated parameters	
Pump model	CHM3-80
Part NO.	1100178554
Rated flow (m <sup>3</sup> /h)	3
Rated head (m)	47
Rated efficiency (%)	58
Power (kW)	0.662
NPSHr (m)	1.8
Speed (rpm)	2900
Max impeller diameter (mm)	82
Medium	
Pumped medium	Clean Water
Working temperature (°C)	20
Medium density (kg/m <sup>3</sup> )	1000
Viscosity (mm <sup>2</sup> /s)	1

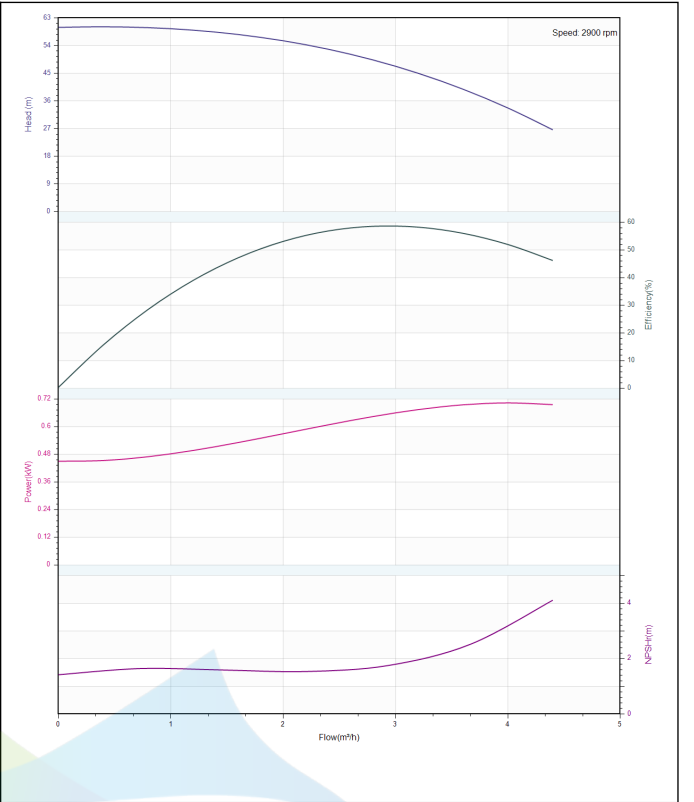

	<b>Structure picture</b> <b>CHM3-80</b>	Manufacturer	CNP
		Address	Yuhang District, Hangzhou, Zhejiang,
Project Name		Contact	86-571-88637351
		Date	2022/03/07
Item NO		Client Name	DPA
		Client Addr.	
		Contacts	Alireza
		Contact	

CHM1, 3-200801

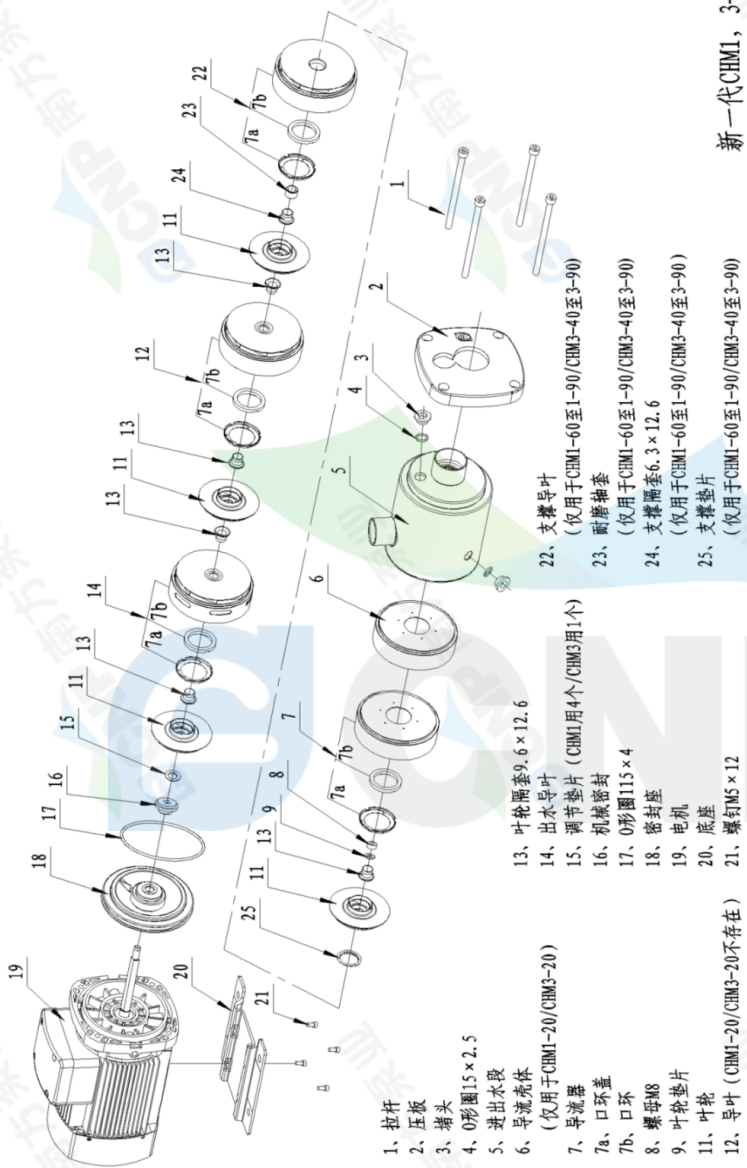

- 1、拉杆
- 2、压板
- 3、堵头
- 4、O形圈15×2.5
- 5、进出水段
- 6、导流壳体  
(仅用于CHM1-20/CHM3-20)
- 7、导流器
- 7a、口环盖
- 7b、口环
- 8、螺母M8
- 9、叶轮垫片
- 11、叶轮
- 12、导叶 (CHM1-20/CHM3-20不存在)
- 13、叶轮隔套9.6×12.6
- 14、出水导叶
- 15、调节垫片 (CHM1用4个/CHM3用1个)
- 16、机械密封
- 17、O形圈115×4
- 18、密封垫
- 19、电机
- 20、底座
- 21、螺钉M5×12
- 22、支撑导叶  
(仅用于CHM1-60至1-90/CHM3-40至3-90)
- 23、耐磨轴套  
(仅用于CHM1-60至1-90/CHM3-40至3-90)
- 24、支撑隔套6.3×12.6  
(仅用于CHM1-60至1-90/CHM3-40至3-90)
- 25、支撑垫片  
(仅用于CHM1-60至1-90/CHM3-40至3-90)

新一代CHM1, 3-200801

插图
修改
旧版图号
新版图号
签字
日期

		<b>爆炸图</b>	
		轻型卧式多级离心泵 CHM1, 3-200801	
标记/图号	更改文件名称	签字	日期
设计	标准化	标准	
校对	审定	日期	
审核			
工艺			
图样标记 S		重量	比例
共 1 页		第 1 页	1:1



### Dimension Drawing CHM3-80

Manufacturer	CNP
Address	Yuhang District, Hangzhou, Zhejiang,
Contact	86-571-88637351
Date	2022/03/07
Client Name	DPA
Client Addr.	
Contacts	Alireza
Contact	

Project Name

Item NO

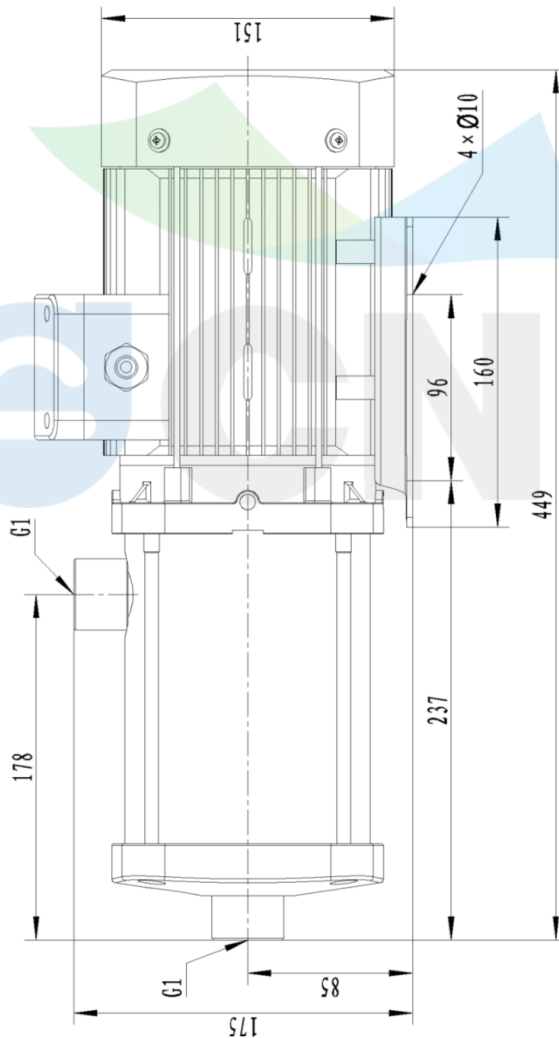
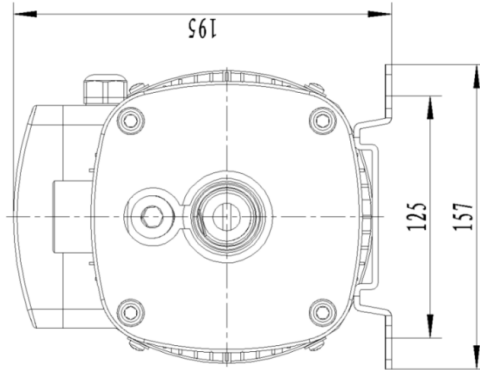

CHM3-80 50HZ