	Product Information CHM3-50	Manufacturer	CNP
		Address	Yuhang District, Hangzhou, Zhejiang,
Project Name		Contact	86-571-88637351
		Date	2022/03/07
Item NO		Client Name	DPA
		Client Addr.	
		Contacts	Alireza
		Contact	

Part NO.	1100178551
----------	------------

Product Picture	Note
	<p>Non-self-priming horizontal multistage centrifugal pump. The impeller guide vane is made of stainless steel plate stamping and welding. Equipped with long shaft motor, axial inlet and radial outlet.</p>

technology

Pump rotator speed 2900

Material

Impeller 304

Rubber code F

Material Code S

Installation

Connection Code L

Installation type horizontal

Maximum Operation Pressure 10Bar

Medium

Medium Temperature normal -15+70

Medium Temperature high t -15+105

Maximum Environment Temper 40

Structure dimension

Inlet & outlet size types G

Inlet & Outlet Diameter G1

Rotation Direction Clockwise

Motor

Number of Motor Phase Three Phase

Protection Class IP55

Insulation Class F

Motor Power 0.55

Energy Efficiency Level IE2

Seal

Mechanical Seal CHM-14/SB1F4

Others

Weight (kg) 11



Performance Curve CHM3-50

Manufacturer	CNP
Address	Yuhang District, Hangzhou, Zhejiang,
Contact	86-571-88637351
Date	2022/03/07
Client Name	DPA
Client Addr.	
Contacts	Alireza
Contact	

Project Name	
Item NO	

The hydraulic performance curve have been tested with Clean Water at 20°C, density 1000kg/m³, and at 1bar atmospheric pressure. ISO99062012 Grade 3B

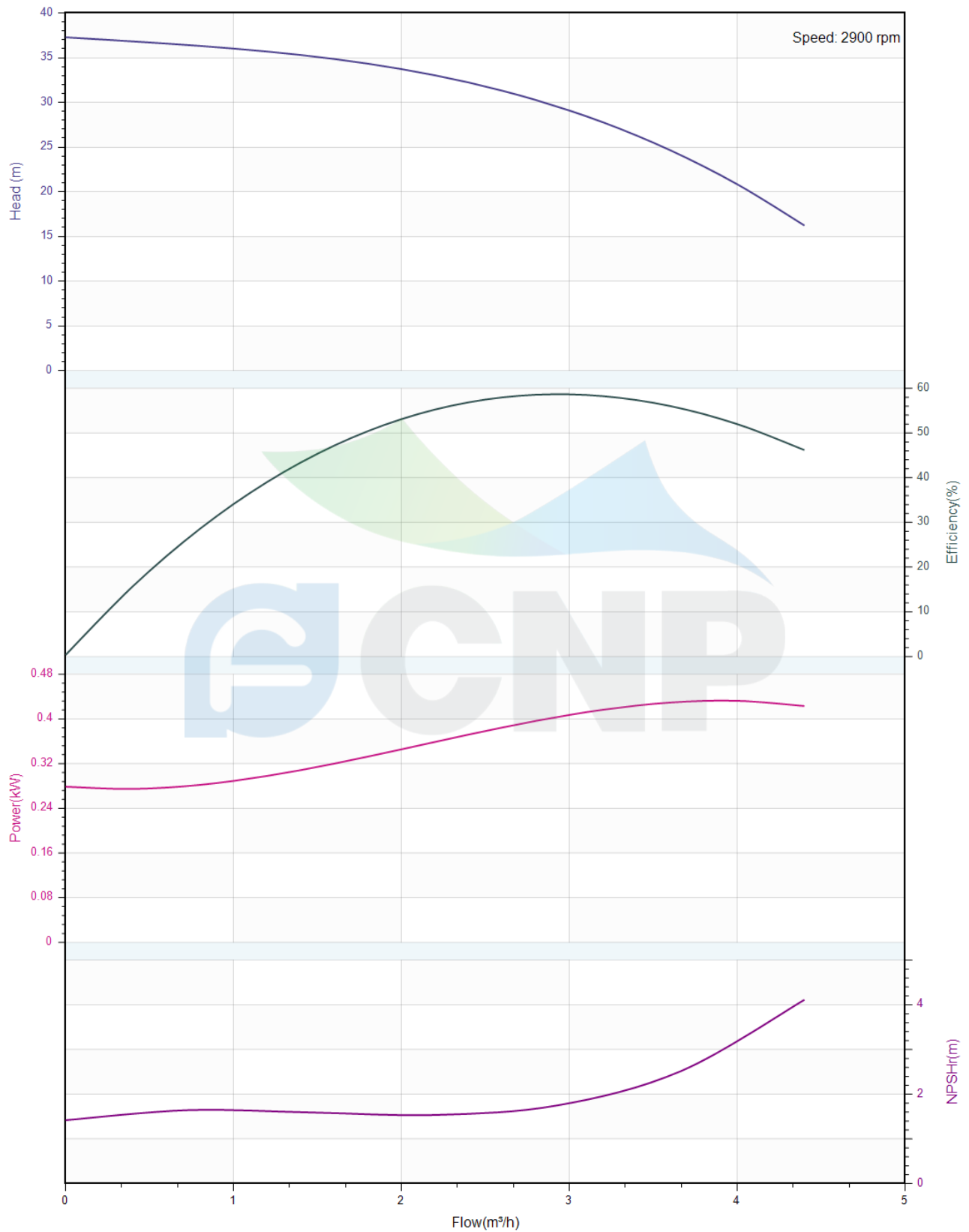



Pump Technical Parameters CHM3-50

Manufacturer	CNP
Address	Yuhang District, Hangzhou, Zhejiang,
Contact	86-571-88637351
Date	2022/03/07
Client Name	DPA
Client Addr.	
Contacts	Alireza
Contact	

Rated parameters

Pump model	CHM3-50
Part NO.	1100178551
Rated flow (m ³ /h)	3
Rated head (m)	29
Rated efficiency (%)	58
Power (kW)	0.409
NPSHr (m)	1.8
Speed (rpm)	2900
Max impeller diameter (mm)	82

Medium

Pumped medium	Clean Water
Working temperature (°C)	20
Medium density (kg/m ³)	1000
Viscosity (mm ² /s)	1

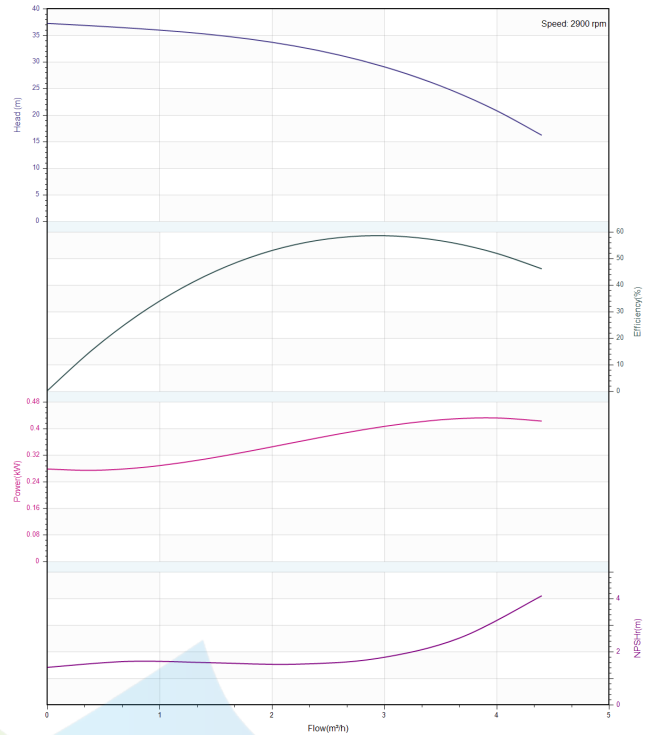

	Structure picture CHM3-50	Manufacturer	CNP
		Address	Yuhang District, Hangzhou, Zhejiang,
Project Name		Contact	86-571-88637351
		Date	2022/03/07
Item NO		Client Name	DPA
		Client Addr.	
		Contacts	Alireza
		Contact	

CHM1, 3-200801

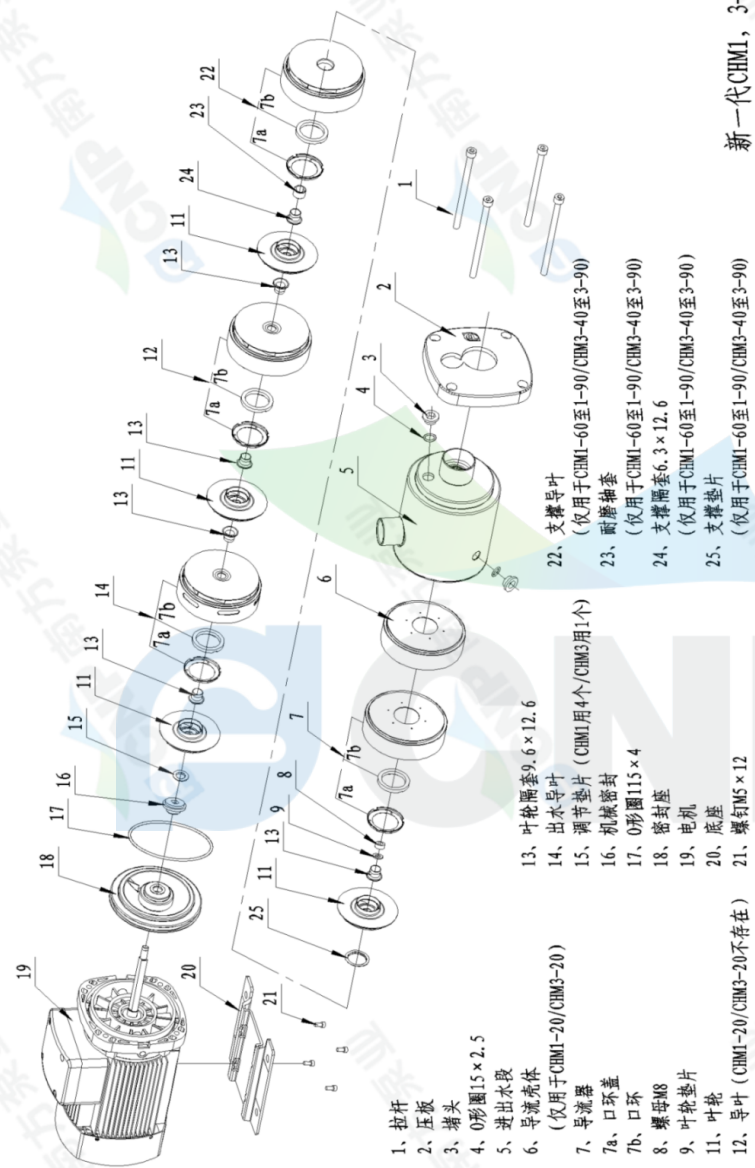

- 1、拉杆
- 2、压板
- 3、堵头
- 4、O形圈15×2.5
- 5、进出水段
- 6、导流壳体
(仅用于CHM1-20/CHM3-20)
- 7、导流器
- 7a、口环盖
- 7b、口环
- 8、螺母M8
- 9、叶轮垫片
- 11、叶轮
- 12、导叶 (CHM1-20/CHM3-20不存在)
- 13、叶轮隔套9.6×12.6
- 14、出水导叶
- 15、调节垫片 (CHM1用4个/CHM3用1个)
- 16、机械密封
- 17、O形圈115×4
- 18、密封垫
- 19、电机
- 20、底座
- 21、螺钉M5×12
- 22、支撑导叶
(仅用于CHM1-60至1-90/CHM3-40至3-90)
- 23、耐磨轴套
(仅用于CHM1-60至1-90/CHM3-40至3-90)
- 24、支撑隔套6.3×12.6
(仅用于CHM1-60至1-90/CHM3-40至3-90)
- 25、支撑垫片
(仅用于CHM1-60至1-90/CHM3-40至3-90)

新一代CHM1, 3-200801

插图
修改
旧版图号
新版图号
签字
日期

		爆炸图	
		轻型卧式多级离心泵 CHM1, 3-200801	
标记/图号	更改文件名称	签字	日期
设计	标准化	标准	
校对	审定	日期	
审核			
工艺			
图样标记 S		重量	比例
共 1 页		第 1 页	1:1



Dimension Drawing CHM3-50

Manufacturer	CNP
Address	Yuhang District, Hangzhou, Zhejiang,
Contact	86-571-88637351
Date	2022/03/07
Client Name	DPA
Client Addr.	
Contacts	Alireza
Contact	

Project Name

Item NO

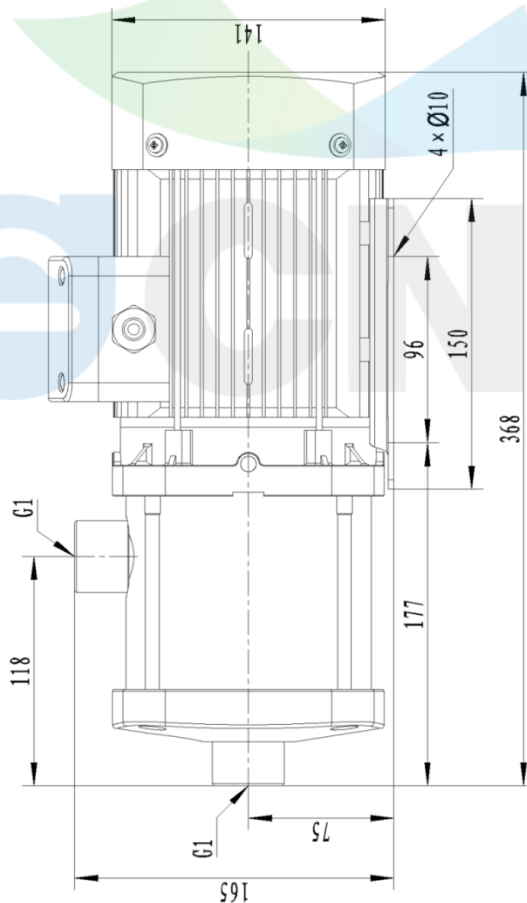
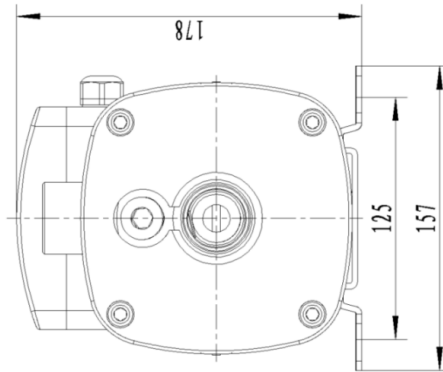

CHM3-50 50HZ