

Receiver
From

 Society
 Reference
 Address
 Phone
 Fax
 E-mail

Item n° :

60141696

Model :

DIG 5500 AP T-NA

Pump data

 Free passage : 10 mm
 Min. fluid temperature : 32 °F
 Max. fluid temperature : 95 °F

Requested data

 Flow :
 Head :
 Fluid : Water, pure
 Fluid Temperature : 68 °F
 Density : 62/322 lb/ft³
 Kinematic viscosity : 1/0818E-5 ft²/s
 Vapor pressure : 2/337 kPa

Hydraulic data (duty point)

 Flow : 0 US g.p.m.
 Head : 0 m

Materials

 Power supply cable 07RN8-F
 Cover Cast iron (EN GJL 200)
 Rotor shaft AISI 420
 Bearing flange Cast iron (EN GJL 200)
 OR NBR
 External sleeve Stainless Steel AISI 304
 Mechanical seal motor side Silicon carbide/Silicon carbide
 Mechanical seal pump side Silicon carbide/Silicon carbide
 Impeller CRA2 650 HB high-chromium cast iron
 Pump body Anti-abrasive rubber 70SHORE
 Suction strainer Stainless Steel AISI 304

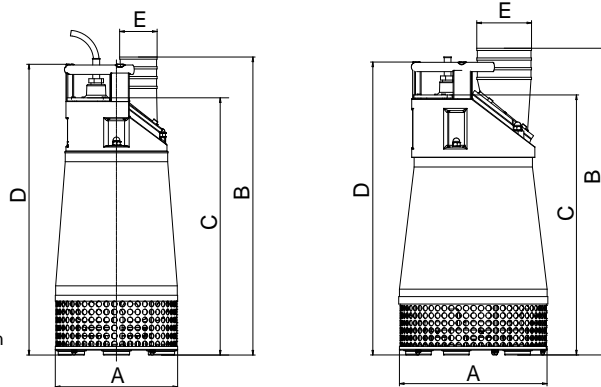
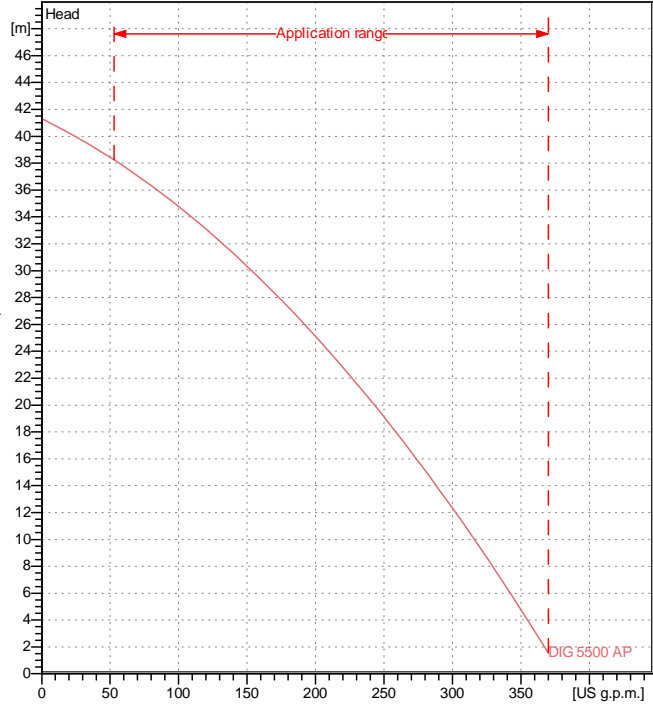
Curve tolerance according to ISO 9906

Motor data

 Nominal power P2 : 5/5 kW
 Rated speed : 2900 rpm
 Rated voltage : 3~ 400 V 50 Hz
 Nominal current : 12 A
 Degree of protection : IP 68

Dimensions in mm

A	326	E	3"
B	840		
C	685		
D	775		

 Suction side : /
 Discharge side : 3" G / --
 Weight : 96 kg