

Receiver
From

Society
 Reference
 Address
 Phone
 Fax
 E-mail

Item n° :

60122636

Model :

VERTY NOVA 200 M

Pump data

Free passage : 5 mm

Pressure rating :

Min. fluid temperature :

Max. fluid temperature :

Max. Ambient temperature :

Requested data

Flow : 0 US g.p.m.

Head : 0 m

Fluid : Water, pure

Fluid Temperature : 68 °F

Density : 62/322 lb/ft³

Kinematic viscosity : 1/0818E-5 ft²/s

Vapor pressure : 2/337 kPa

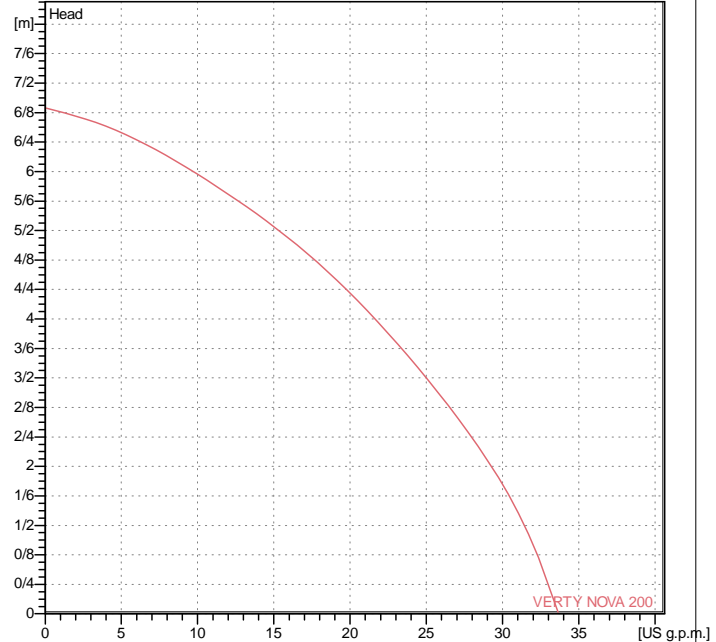
Curve tolerance according to ISO 9906

Hydraulic data (duty point)

Flow :

Head :

Materials

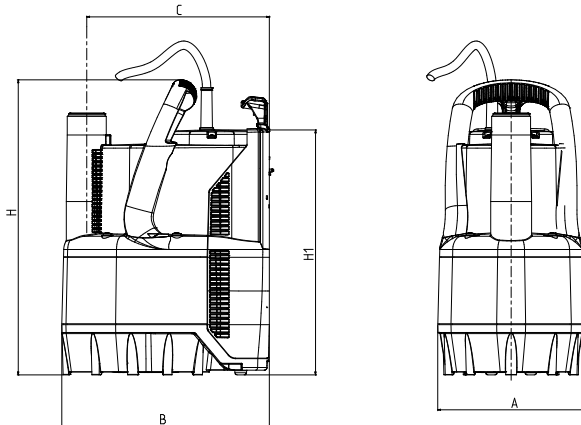
Pump body	Technopolymer
Impeller	Noryl
Motor casing	Stainless Steel AISI 304
Motor shaft	AISI 416 X12 CrS 13 UNI EN 10088-1
Float	Technopolymer
OR ring	NBR 70
Filter	Technopolymer

Motor data
Weight : 4/2 kg

Motor brand :	DAB
Nominal power P2 :	0/2 kW
Rated speed :	2800 rpm
Rated voltage :	1~ 220-240 V
Nominal current :	1/3 A
Degree of protection :	IP X8

50 Hz

Dimensions in mm

Dimension	Value (mm)				
A	158				
B	225				
C	200				
D	33				
H	318				
H1	265				

Pump connection

Suction side :	/
Discharge side :	/