

Receiver
From

 Society
 Reference
 Address
 Phone
 Fax
 E-mail

Item n° :

103040040

Model :

FEKA VS 750 M - A

Pump data

 Free passage : 50 mm
 Pressure rating :
 Min. fluid temperature : 0
 Max. fluid temperature : 122 °F
 Max. Ambient temperature : 104 °F

Requested data

 Flow : 0 US g.p.m.
 Head : 0 m
 Fluid : Water, pure
 Fluid Temperature : 68 °F
 Density : 62/322 lb/ft³
 Kinematic viscosity : 1/0818E-5 ft²/s
 Vapor pressure : 2/337 kPa

Hydraulic data (duty point)

 Flow :
 Head :

Materials

 Pump body : Stainless Steel (AISI 304)
 Impeller : Stainless Steel (AISI 304)
 Motor shaft : AISI 316
 Seal disk : Stainless Steel (AISI 304)
 Motor casing : Stainless Steel (AISI 304)
 Protection cover : Stainless Steel (AISI 304)
 Mechanical seal pump side : Silicon carbide/Silicon carbide

Motor data

 Motor brand : DAB
 Nominal power P2 : 0/75 kW
 Rated speed : 2800 rpm
 Rated voltage : 1~ 220-240 V
 Nominal current : 5/13 A
 Degree of protection : IP 68

50 Hz

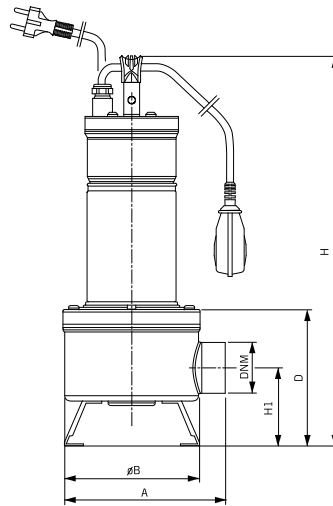
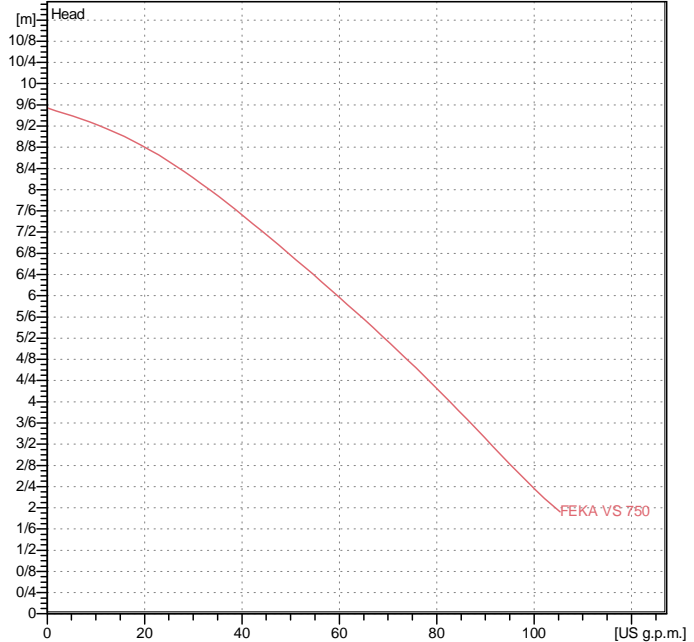
Curve tolerance according to ISO 9906

Weight : 17/5 kg

Dimensions in mm

Dimension	Value				
A	203				
B	170				
D	172				
DNM	2" F				
H	492				
H1	98				

Pump connection

 Suction side : /
 Discharge side : 2" F / --