

Receiver
From

 Society
 Reference
 Address
 Phone
 Fax
 E-mail

Item n° :

505826041

Model :

D 80/250.40 M

Pump data

 Pressure rating : PN 10
 Min. fluid temperature : 14 °F
 Max. fluid temperature : 230 °F

Minimum suction head :

 Temperature °F 194
 Minimum suction head : m 2/5

Requested data

 Flow : 0/00 US g.p.m.
 Head : 0/00 m
 Fluid (%) : Water, pure
 Fluid Temperature : 68 °F
 Density : 62/322 lb/ft³
 Kinematic viscosity : 1/0818E-5 ft²/s
 Vapor pressure : 2/34 kPa

Hydraulic data (duty point)

 Flow :
 Head :
 Rated speed : 2674 rpm

Materials

 Pump body : Cast iron
 Impeller : Technopolymer
 Motor shaft : Stainless steel
 Air vent plug : Brass
 Seal ring : Etyilene propylene
 Motor casing : Die cast aluminium
 Stator jacket : Stainless steel

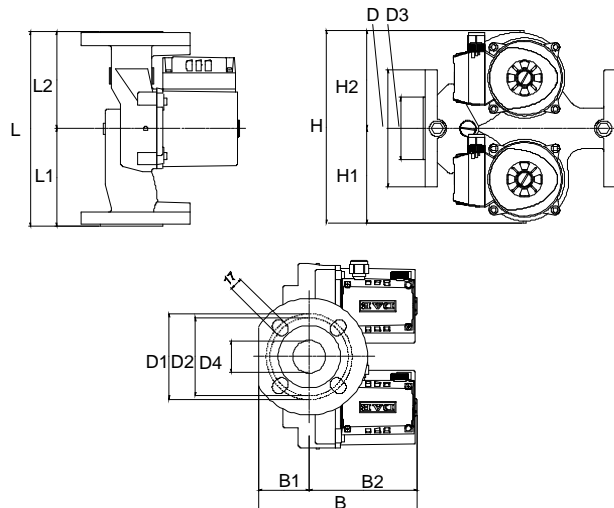
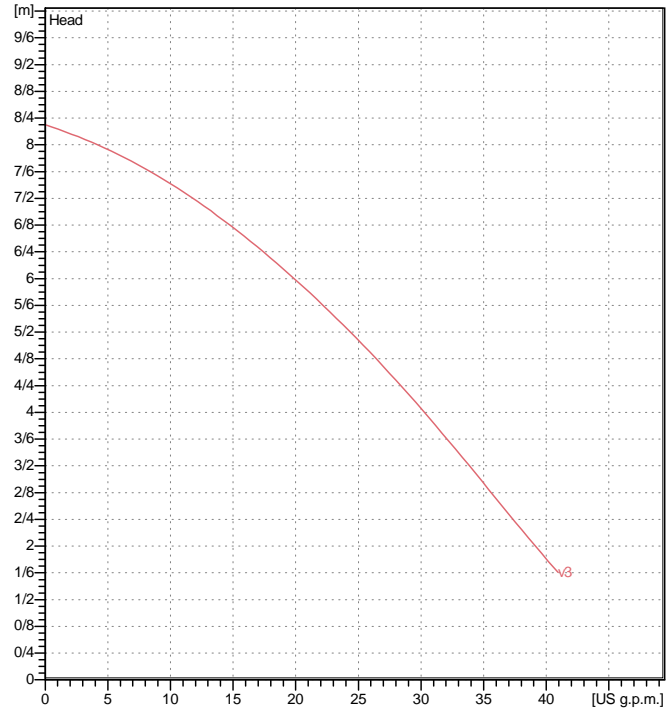
Curve tolerance according to ISO 9906

Motor data

 Motor brand : DAB
 Nominal power P2 : 0/192 kW
 Rated speed : 2683 rpm
 Rated voltage : 1~ 230 V 50 Hz
 Nominal current : 1/12 A
 Degree of protection : IP 44

Dimensions in mm

B	204	D1	110	F	DN40/PN10	250
B1	65	D2	100	H	247	L1 125
B2	139	D3	80	H1	122	L2 125
D	150	D4	40	H2	126	

Weight : 14/2 kg

Pump connection

 Suction side : DN 40 / PN 10
 Discharge side : DN 40 / PN 10