

Receiver
From

 Society
 Reference
 Address
 Phone
 Fax
 E-mail

Item n° :

505940622

Model :

BMH 30/340.65 T

Pump data

 Pressure rating : PN 10
 Min. fluid temperature : 14 °F
 Max. fluid temperature : 248 °F

Minimum suction head :

Temperature	°F	167	194	230	248
Minimum suction head :	m	4	7/5	--	21

Requested data

 Flow : 0/00 US g.p.m.
 Head : 0/00 m
 Fluid (%) : Water, pure
 Fluid Temperature : 68 °F
 Density : 62/322 lb/ft³
 Kinematic viscosity : 1/0818E-5 ft²/s
 Vapor pressure : 2/34 kPa

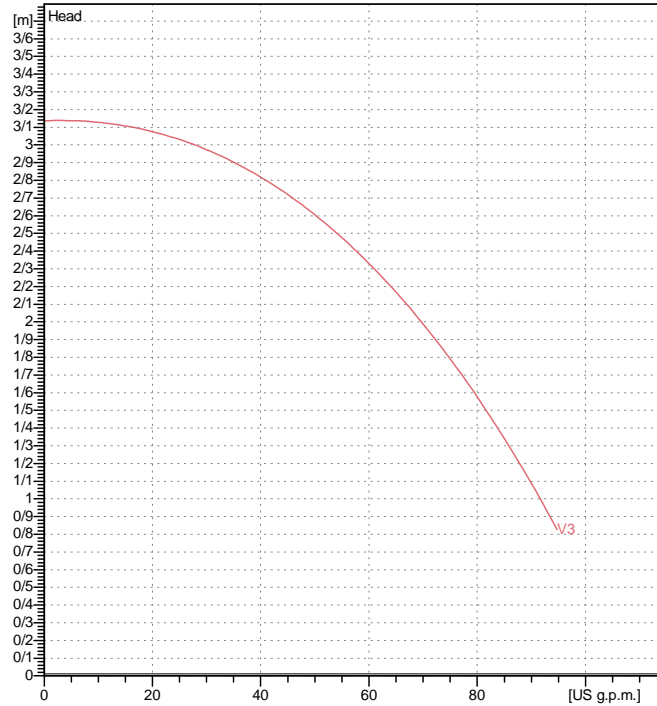
Curve tolerance according to ISO 9906

Hydraulic data (duty point)

 Flow :
 Head :

Materials

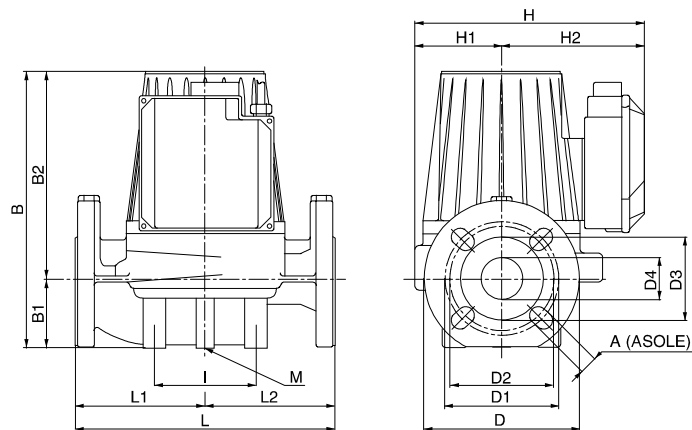
Pump body	Cast iron 200 UNI ISO 185
Impeller	Technopolymer B
Motor shaft	AISI 420 C
Air vent plug	Brass P Cu Zn40 Pb2 UNI 5705
Seal ring	Ethylene propylene (EPDM)
Motor casing	Die cast aluminium
Stator jacket	AISI 321Bon. - AISI 304

Motor data

Motor brand :	DAB
Power input P1 :	0/27 kW
Rated speed :	1450 rpm
Rated voltage :	3~ 400 V 50 Hz
Nominal current :	1/12 A
Degree of protection :	IP 44

Dimensions in mm

A	18	D	185	D4	65	I	100
B	334	D1	145	H	259	I1	-
B1	82	D2	130	H1	100	I2	-
B2	252	D3	110	H2	159	I3	-

Weight : 27/5 kg

Pump connection

 Suction side : DN 65 / PN 10
 Discharge side : DN 65 / PN 10