

Receiver
From

 Society
 Reference
 Address
 Phone
 Fax
 E-mail

Item n° :

60121344

Model :

AQUAJET 102 M-G

Pump data

 Pressure rating : 8 bar (800 kPa)
 Min. fluid temperature : 32 °F
 Max. fluid temperature : 95 °F
 Max. Ambient temperature : 104 °F

Priming capacity :

H	m	2	3	4	5	6	7	8	9
Q	US g.p.m.	18/5	12/4	10/8	10	8/98	7/4	6/08	4/76

Requested data

 Flow : 0/00 US g.p.m.
 Head : 0/00 m
 Fluid : Water, pure
 Fluid Temperature : 68 °F
 Density : 62/322 lb/ft³
 Kinematic viscosity : 1/0818E-5 ft²/s
 Vapor pressure : 2/34 kPa

Hydraulic data (duty point)

 Flow :
 Head :

Materials

 Pump body : Cast iron 200 UNI ISO 185
 Support : Die cast aluminium
 Impeller : Technopolymer A
 Mechanical seal : Carbon/Ceramic
 OR ring : NBR Rubber
 Shaft with rotor : AISI 416 X12 CrS 13 UNI 6900/71
 Nozzle venturi dif fuser assembly : Technopolymer A

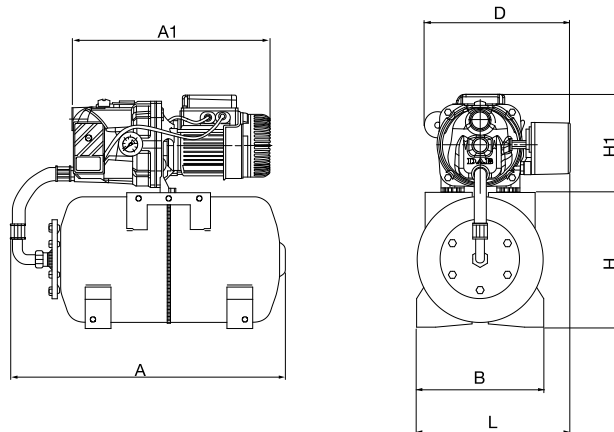
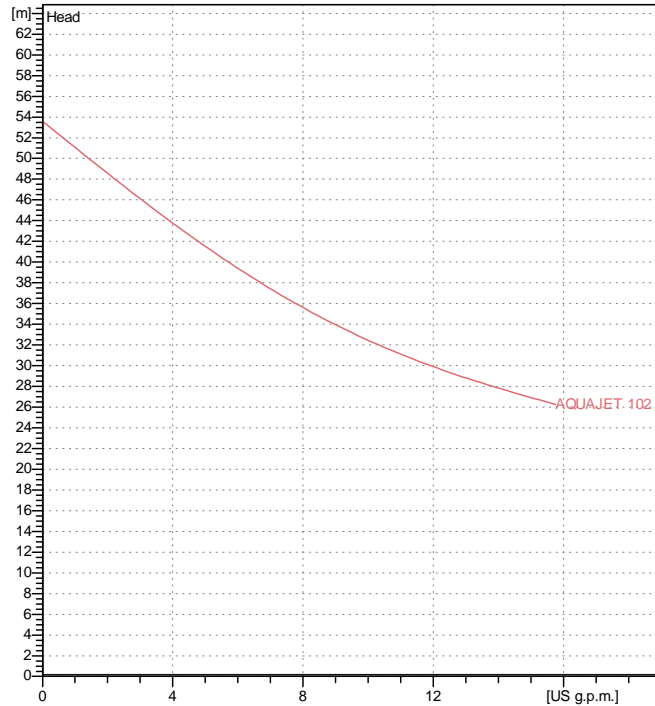
Curve tolerance according to ISO 9906

Motor data

 Motor brand : DAB
 Nominal power P2 : 0/75 kW
 Rated speed : 2800 rpm
 Rated voltage : 1~ 220-240 V
 Nominal current : 5/1 A
 Degree of protection : IP 44

50 Hz

Dimensions in
mm

A	492	DNA	1" G	L	301		
A1	413	DNM	1" G				
B	263	H	296				
D	256	H1	204				

Weight : 19/8 kg

Pump connection

 Suction side : 1 " G / 8 bar (800 kPa)
 Discharge side : 1 " G / 8 bar (800 kPa)