

Receiver
From

 Society
 Reference
 Address
 Phone
 Fax
 E-mail

Item n° :

60141726

Model :

FEKA 2515.2 T

Pump data

 Free passage : 62 mm
 Pressure rating :
 Min. fluid temperature : 32 °F
 Max. fluid temperature : 131 °F
 Max. Ambient temperature : 104 °F

Requested data

 Flow : 0 US g.p.m.
 Head : 0 m
 Fluid : Water, pure
 Fluid Temperature : 68 °F
 Density : 62/322 lb/ft³
 Kinematic viscosity : 1/0818E-5 ft²/s
 Vapor pressure : 2/337 kPa

Hydraulic data (duty point)

 Flow :
 Head :

Materials

 Pump body : Cast iron 200 UNI ISO 185
 Impeller : Cast iron 200 UNI ISO 185
 Pump body OR ring : NBR
 Motor shaft : AISI 416 X12 CrS 13 UNI 6900/71
 Motor casing : Cast iron 200 UNI ISO 185
 Protection cover : Cast iron 200 UNI ISO 185
 Mechanical seal : Silicon carbide

Motor data

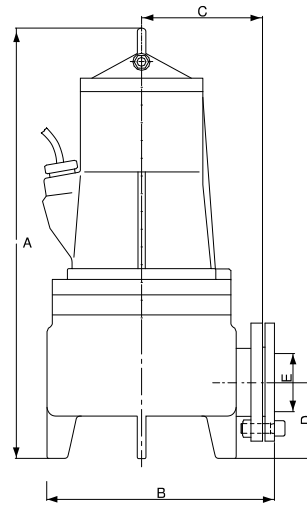
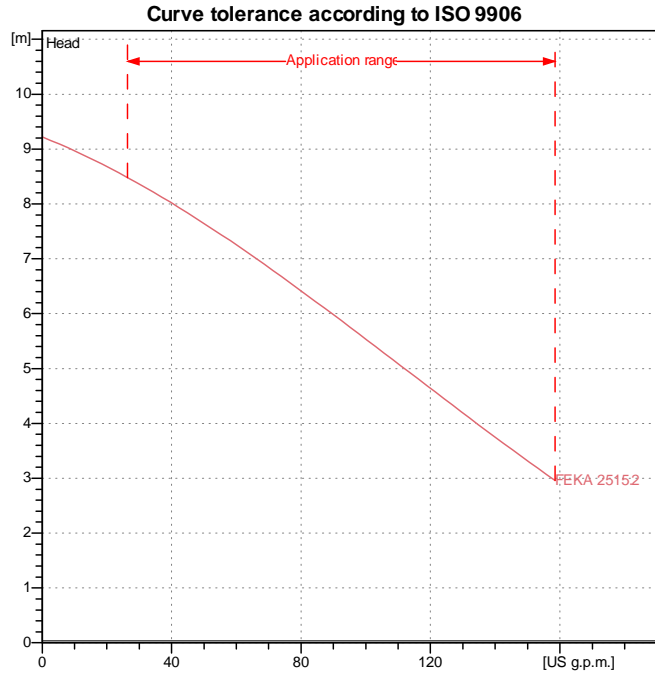
 Motor brand : DAB
 Nominal power P2 : 1/1 kW
 Rated speed : 2800 rpm
 Rated voltage : 3~ 400 V 50 Hz
 Nominal current : 3/3 A
 Degree of protection : IP 68

Weight : 41 kg

Dimensions in mm

A	515				
B	273				
C	158				
D	90				
E	62				

Pump connection

 Suction side : /
 Discharge side : DN 65 / --