

Receiver
From

 Society
 Reference
 Address
 Phone
 Fax
 E-mail

Item n° :

1D2311000

Model :

KDN 40-200/XXX/A/BAQE

Pump data

Impeller size	219 mm
Hydraulic curve at rpm:	
Rated speed :	1450 rpm
Coupling :	
MEI \geq 0,60	
Pressure rating :	PN 16
Min. fluid temperature :	14 °F
Max. fluid temperature :	284 °F
Max. Ambient temperature :	104 °F

Requested data

Flow :	0/00 US g.p.m.
Head :	0/00 m
Fluid (%) :	Water, pure
Fluid Temperature :	68 °F
Density :	62/322 lb/ft ³
Kinematic viscosity :	1/0818E-5 ft ² /s
Vapor pressure :	2/34 kPa

Hydraulic data (duty point)

Flow :	
Head :	
NPSH :	
Shaft power P2 :	
Efficiency :	

Materials

Pump body	Cast iron 250 UNI ISO 185
Impeller	Cast iron 250 UNI ISO 185
Pump shaft	AISI 420 - UNI 6900/71
OR ring	Viton
Seal disk	Cast iron 250 UNI ISO 185
Mechanical seal	SEE "SHAFT SEAL" SECTION
Seal spacer	AISI 304 - UNI 6900/71

Shaft seal

Type	Rubber
Stationary part	Carbon
Rotating part	Silicon carbide
Elastomer	EPDM

Motor data

Nominal power P2 :	
Rated speed :	
Rated voltage :	
Nominal current :	
Degree of protection :	

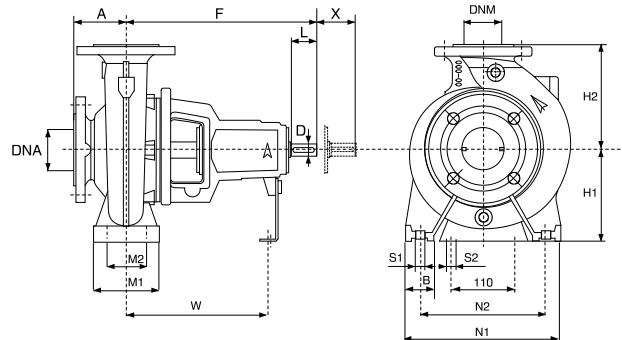
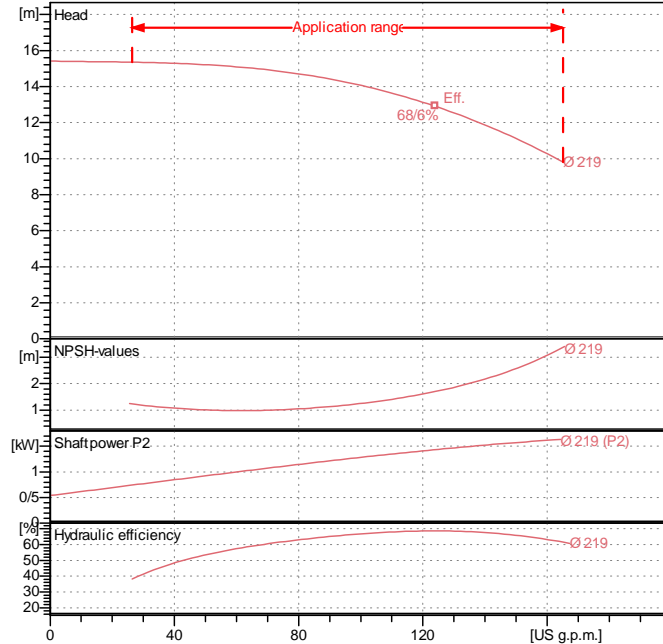
Curve tolerance according to ISO 9906

Weight : 51 kg

Dimensions in mm

A	100	H2	180	S2	M12
B	50	L	50	W	260
D	24	M1	100	X	100
DNA	65	M2	70		
DNM	40	N1	265		
F	360	N2	212		
H1	160	S1	M12		

Pump connection

Suction side :	DN 65 / PN 16
Discharge side :	DN 40 / PN 16