

**Receiver**
**From**

 Society  
 Reference  
 Address  
 Phone  
 Fax  
 E-mail

**Item n° :**

1D2211000

**Model :**

KDN 40-160/XXX/A/BAQE

**Pump data**

Impeller size	177 mm
Hydraulic curve at rpm:	
Rated speed :	1450 rpm
Coupling :	
MEI $\geq$ 0,40	
Pressure rating :	PN 16
Min. fluid temperature :	14 °F
Max. fluid temperature :	284 °F
Max. Ambient temperature :	104 °F

**Requested data**

Flow :	0/00 US g.p.m.
Head :	0/00 m
Fluid (%) :	Water, pure
Fluid Temperature :	68 °F
Density :	62/322 lb/ft <sup>3</sup>
Kinematic viscosity :	1/0818E-5 ft <sup>2</sup> /s
Vapor pressure :	2/34 kPa

**Hydraulic data (duty point)**

Flow :	
Head :	
NPSH :	
Shaft power P2 :	
Efficiency :	

**Materials**

Pump body	Cast iron 250 UNI ISO 185
Impeller	Cast iron 250 UNI ISO 185
Pump shaft	AISI 420 - UNI 6900/71
OR ring	Viton
Seal disk	Cast iron 250 UNI ISO 185
Mechanical seal	SEE "SHAFT SEAL" SECTION
Seal spacer	AISI 304 - UNI 6900/71

**Shaft seal**

Type	Rubber
Stationary part	Carbon
Rotating part	Silicon carbide
Elastomer	EPDM

**Motor data**

Nominal power P2 :	
Rated speed :	
Rated voltage :	
Nominal current :	
Degree of protection :	

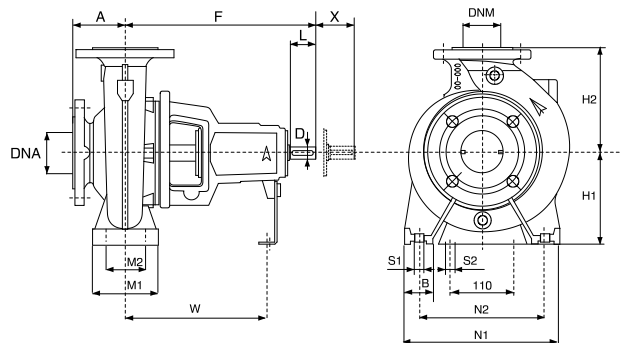
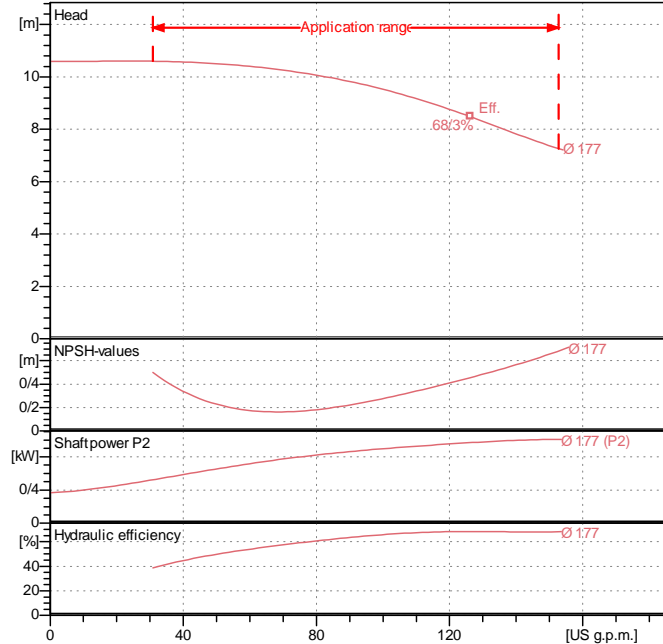
**Curve tolerance according to ISO 9906**

**Weight :** 41 kg

**Dimensions in mm**

A	80	H2	160	S2	M12
B	50	L	50	W	260
D	24	M1	100	X	100
DNA	65	M2	70		
DNM	40	N1	240		
F	360	N2	190		
H1	132	S1	M12		

**Pump connection**

Suction side :	DN 65 / PN 16
Discharge side :	DN 40 / PN 16