

Receiver
From

 Society
 Reference
 Address
 Phone
 Fax
 E-mail

Item n° :

103002694

Model :

NOVA 180 M-NA SV

Pump data

 Free passage : 5 mm
 Pressure rating :
 Min. fluid temperature : 32 °F
 Max. fluid temperature : 95 °F
 Max. Ambient temperature : 104 °F

Requested data

 Flow : 0 US g.p.m.
 Head : 0 m
 Fluid : Water, pure
 Fluid Temperature : 68 °F
 Density : 62/322 lb/ft³
 Kinematic viscosity : 1/0818E-5 ft²/s
 Vapor pressure : 2/337 kPa

Hydraulic data (duty point)

 Flow :
 Head :

Materials

 Pump body : Technopolymer
 Impeller : Technopolymer
 OR ring : NBR Rubber
 Motor top body : AISI 304 X5 Cr Ni 1810 UNI 6900/71
 Rotor shaft : AISI 431
 Seeger ring : 12E - UNI 7435 STAINLESS
 Suction strainer : Technopolymer

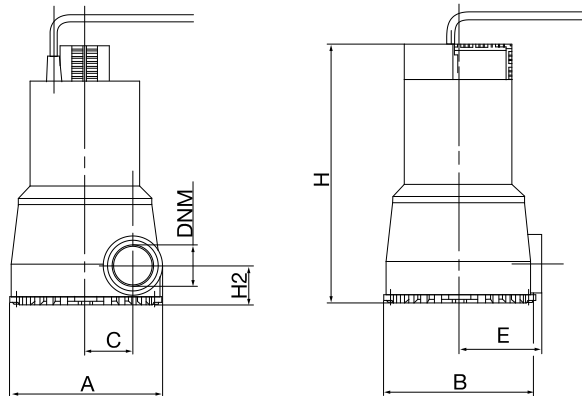
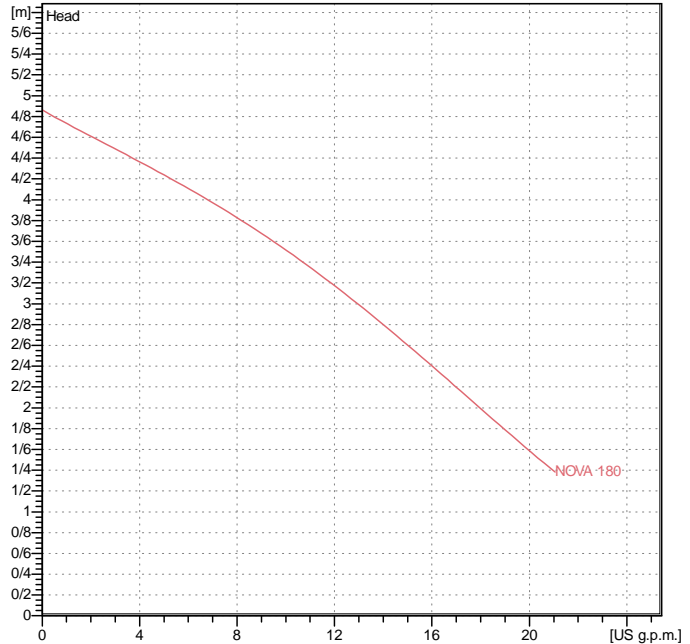
Curve tolerance according to ISO 9906

Motor data
Weight : 4/5 kg

 Motor brand : DAB
 Nominal power P2 : 0/2 kW
 Rated speed : 2900 rpm
 Rated voltage : 1~ 220-240 V
 Nominal current : 0/9 A
 Degree of protection : IP 68

50 Hz

Dimensions in mm

Dimension	Value				
A	148				
B	148				
C	46				
DNM	1" 1/4 G				
E	82				
H	253				
H2	38				

Pump connection

 Suction side : /
 Discharge side : 1" 1/4 G / --