

**Receiver**
**From**

 Society  
 Reference  
 Address  
 Phone  
 Fax  
 E-mail

**Item n° :**

1D5211G5W

**Model :**

CM-G 80-890/A/BAQE/1,5 IE3

**Pump data**

 MEI  $\geq$  0,60

 Pressure rating : PN 16  
 Min. fluid temperature : 14 °F  
 Max. fluid temperature : 284 °F  
 Max. Ambient temperature : 104 °F

**Requested data**

 Flow : 0/00 US g.p.m.  
 Head : 0/00 m  
 Fluid (%) : Water, pure  
 Fluid Temperature : 68 °F  
 Density : 62/322 lb/ft<sup>3</sup>  
 Kinematic viscosity : 1/0818E-5 ft<sup>2</sup>/s  
 Vapor pressure : 2/34 kPa

**Real duty point**

 Flow :  
 Head :  
 NPSH :  
 Shaft power P2 :  
 Efficiency :

**Materials**

 Pump body : Cast iron 250 UNI ISO 185  
 Support : Cast iron 250 UNI ISO 185  
 Impeller : Cast iron 250 UNI ISO 185  
 Mechanical seal : SEE "SHAFT SEAL" SECTION  
 OR ring : EPDM Rubber  
 Shaft with rotor : AISI 304 X5 Cr Ni 1810 UNI 6900/71

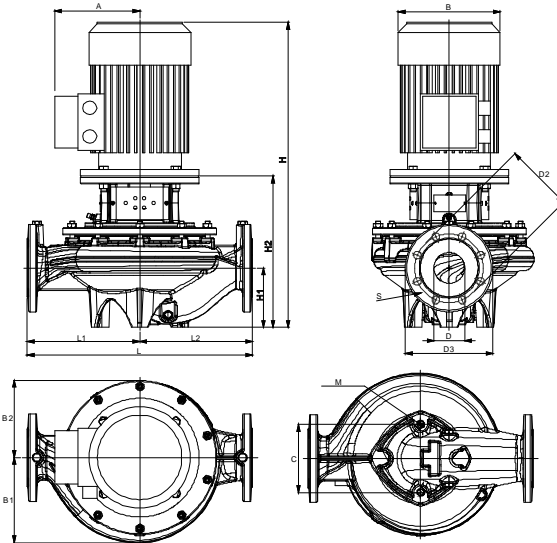
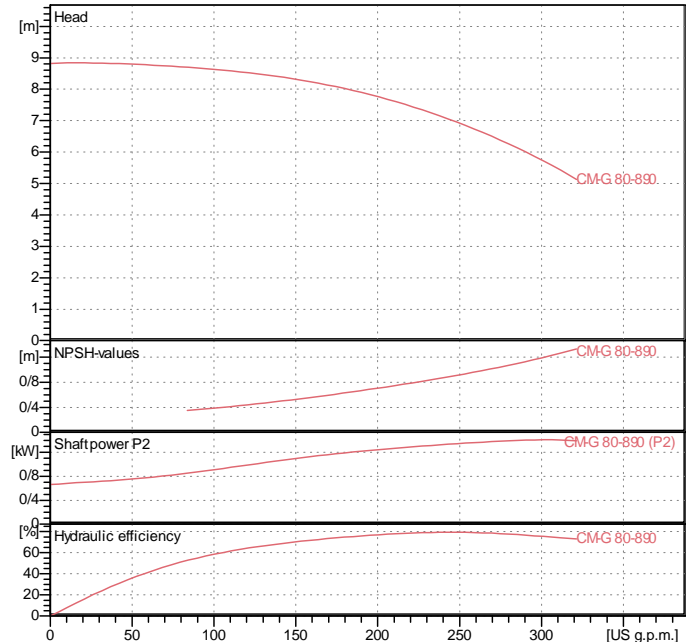
**Curve tolerance according to ISO 9906**

**Shaft seal**

 Type : Rubber  
 Stationary part : Carbon  
 Rotating part : Silicon carbide  
 Elastomer : EPDM

**Motor data**

 Nominal power P2 : 1/5 kW  
 Rated speed : 1435 rpm  
 Rated voltage : 3~ 230 V / 400 V 50 Hz  
 Nominal current : 6/24 / 3/6 A  
 Degree of protection : IP 55

**Weight :** 81 kg

**Dimensions in mm**

Dimension	Value	Dimension	Value	Dimension	Value
A	160	H	626	S	8 x ?18
B1	178	H1	115		
B2	145	H2	291		
C	144	L	440		
D	80	L1	220		
D2	160	L2	220		
D3	200	M	M16		

**Pump connection**

 Suction side : DN 80 / PN 16  
 Discharge side : DN 80 / PN 16