

**Receiver**
**From**

 Society  
 Reference  
 Address  
 Phone  
 Fax  
 E-mail

**Item n° :**

1D5111G3W

**Model :**

CM-G 80-650/A/BAQE/0,75 IE3

**Pump data**

 MEI  $\geq$  0,60

 Pressure rating : PN 16  
 Min. fluid temperature : 14 °F  
 Max. fluid temperature : 284 °F  
 Max. Ambient temperature : 104 °F

**Requested data**

 Flow : 0/00 US g.p.m.  
 Head : 0/00 m  
 Fluid (%) : Water, pure  
 Fluid Temperature : 68 °F  
 Density : 62/322 lb/ft<sup>3</sup>  
 Kinematic viscosity : 1/0818E-5 ft<sup>2</sup>/s  
 Vapor pressure : 2/34 kPa

**Real duty point**

 Flow :  
 Head :  
 NPSH :  
 Shaft power P2 :  
 Efficiency :

**Materials**

 Pump body : Cast iron 250 UNI ISO 185  
 Support : Cast iron 250 UNI ISO 185  
 Impeller : Cast iron 250 UNI ISO 185  
 Mechanical seal : SEE "SHAFT SEAL" SECTION  
 OR ring : EPDM Rubber  
 Shaft with rotor : AISI 304 X5 Cr Ni 1810 UNI 6900/71

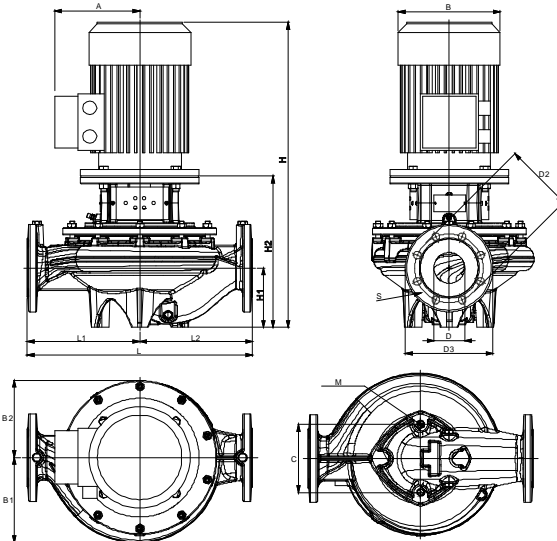
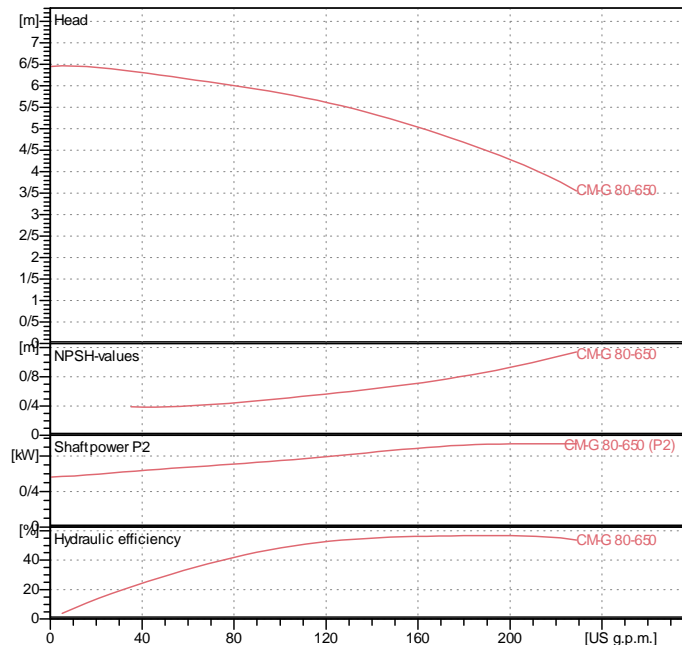
**Curve tolerance according to ISO 9906**

**Shaft seal**

 Type : Rubber  
 Stationary part : Carbon  
 Rotating part : Silicon carbide  
 Elastomer : EPDM

**Motor data**

 Nominal power P2 : 0/75 kW  
 Rated speed : 1400 rpm  
 Rated voltage : 3~ 230 V / 400 V 50 Hz  
 Nominal current : 3/57 / 2/06 A  
 Degree of protection : IP 55

**Weight :** 67 kg

**Dimensions in mm**

Dimension	Value	Dimension	Value	Dimension	Value
A	140	H	536	S	8 x ?18
B1	135	H1	105		
B2	118	H2	281		
C	144	L	360		
D	80	L1	180		
D2	160	L2	180		
D3	200	M	M16		

**Pump connection**

 Suction side : DN 80 / PN 16  
 Discharge side : DN 80 / PN 16