

Receiver
From

 Society
 Reference
 Address
 Phone
 Fax
 E-mail

Item n° :

1D7411GCX

Model :

CM-G 125-2550/A/BAQE/15 IE3

Pump data

 MEI \geq 0,40

 Pressure rating : PN 16
 Min. fluid temperature : 14 °F
 Max. fluid temperature : 284 °F
 Max. Ambient temperature : 104 °F

Requested data

 Flow : 0/00 US g.p.m.
 Head : 0/00 m
 Fluid (%) : Water, pure
 Fluid Temperature : 68 °F
 Density : 62/322 lb/ft³
 Kinematic viscosity : 1/0818E-5 ft²/s
 Vapor pressure : 2/34 kPa

Real duty point

 Flow :
 Head :
 NPSH :
 Shaft power P2 :
 Efficiency :

Materials

 Pump body : Cast iron 250 UNI ISO 185
 Support : Cast iron 250 UNI ISO 185
 Impeller : Cast iron 250 UNI ISO 185
 Mechanical seal : SEE "SHAFT SEAL" SECTION
 OR ring : EPDM Rubber
 Shaft with rotor : AISI 304 X5 Cr Ni 1810 UNI 6900/71

Shaft seal

 Type : Rubber
 Stationary part : Carbon
 Rotating part : Silicon carbide
 Elastomer : EPDM

Motor data

 Nominal power P2 : 15 kW
 Rated speed : 1470 rpm
 Rated voltage : 3~ 400 V 50 Hz
 Nominal current : 28 A
 Degree of protection : IP 55

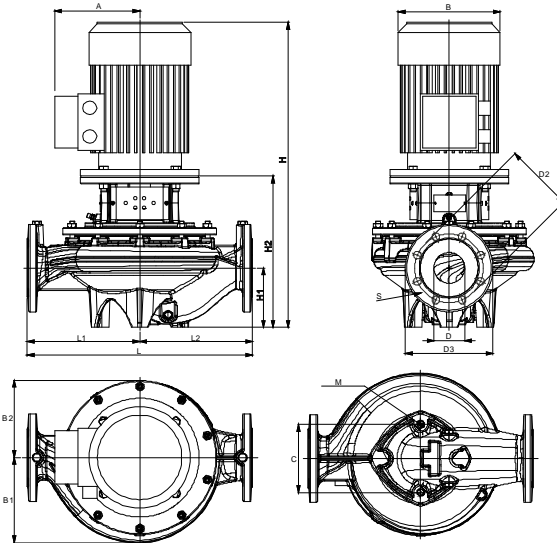
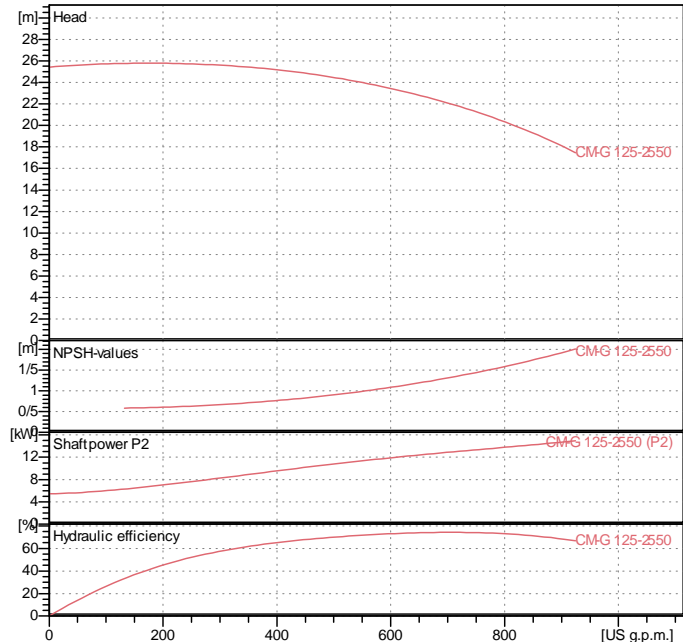
Curve tolerance according to ISO 9906

Weight : 321 kg

Dimensions in mm

Dimension	Value	Dimension	Value	Dimension	Value
A	249	H	1081	S	8 x ?18
B1	273	H1	215		
B2	245	H2	533		
C	230	L	800		
D	125	L1	400		
D2	210	L2	400		
D3	250	M	M16		

Pump connection

 Suction side : DN 125 / PN 16
 Discharge side : DN 125 / PN 16