

Receiver
From

 Society
 Reference
 Address
 Phone
 Fax
 E-mail

Item n° :

1D6511GDX

Model :

CM-G 100-3680/A/BAQE/18,5 IE3

Pump data

 MEI \geq 0,40

Pressure rating : PN 16

Min. fluid temperature : 14 °F

Max. fluid temperature : 284 °F

Max. Ambient temperature : 104 °F

Requested data

Flow : 0/00 US g.p.m.

Head : 0/00 m

Fluid (%) : Water, pure

Fluid Temperature : 68 °F

 Density : 62/322 lb/ft³

 Kinematic viscosity : 1/0818E-5 ft²/s

Vapor pressure : 2/34 kPa

Real duty point

Flow :

Head :

NPSH :

Shaft power P2 :

Efficiency :

Materials

Pump body Cast iron 250 UNI ISO 185

Support Cast iron 250 UNI ISO 185

Impeller Cast iron 250 UNI ISO 185

Mechanical seal SEE "SHAFT SEAL" SECTION

OR ring EPDM Rubber

Shaft with rotor AISI 304 X5 Cr Ni 1810 UNI 6900/71

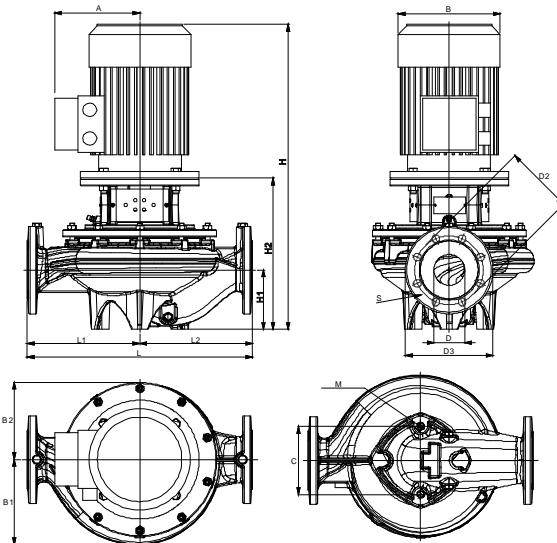
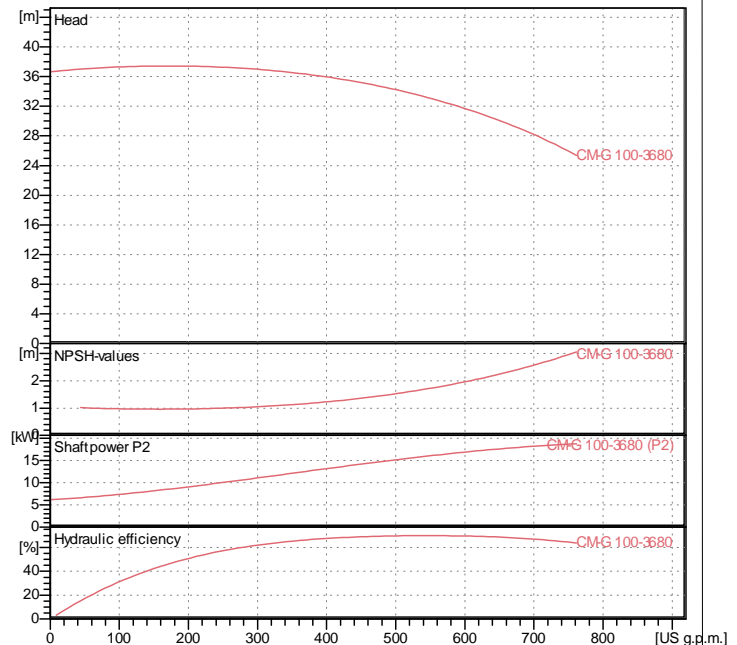
Curve tolerance according to ISO 9906

Shaft seal

Type Rubber

Stationary part Carbon

Rotating part Silicon carbide

Elastomer EPDM

Motor data

Nominal power P2 : 18/5 kW

Rated speed : 1470 rpm

Rated voltage : 3~ 400 V

50 Hz

Nominal current : 34 A

Degree of protection : IP 55

Weight : 359 kg

Dimensions in mm

Dimension	Value	Dimension	Value	Dimension	Value
A	265	H	1063	S	8 x ?18
B1	293	H1	175		
B2	253	H2	483		
C	230	L	670		
D	100	L1	335		
D2	180	L2	335		
D3	220	M	M16		

Pump connection

Suction side : DN 100 / PN 16

Discharge side : DN 100 / PN 16