

**Receiver**
**From**

 Society  
 Reference  
 Address  
 Phone  
 Fax  
 E-mail

**Item n° :**

102972320

**Model :**

EUROINOX 25/80 M-P

**Pump data**

 Pressure rating : 8 bar (800 kPa)  
 Min. fluid temperature : 32 °F  
 Max. fluid temperature : 95 °F  
 Max. Ambient temperature : 104 °F

**Requested data**

 Flow : 0/00 US g.p.m.  
 Head : 0/00 m  
 Fluid : Water, pure  
 Fluid Temperature : 68 °F  
 Density : 62/322 lb/ft³  
 Kinematic viscosity : 1/0818E-5 ft²/s  
 Vapor pressure : 2/34 kPa

**Hydraulic data (duty point)**

 Flow :  
 Head :

**Materials**

 Pump body : AISI 304 X5 Cr Ni 1810 UNI 6900/71  
 Impeller : Technopolymer  
 Shaft with rotor : AISI 304 X5 Cr Ni 1810 UNI 6900/71  
 OR ring : NBR  
 Diffuser : Technopolymer  
 Mechanical seal : Carbon/Ceramic  
 Disc seal : AISI 304 X5 Cr Ni 1810 UNI 6900/71

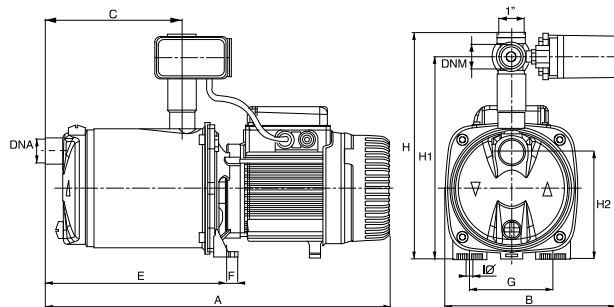
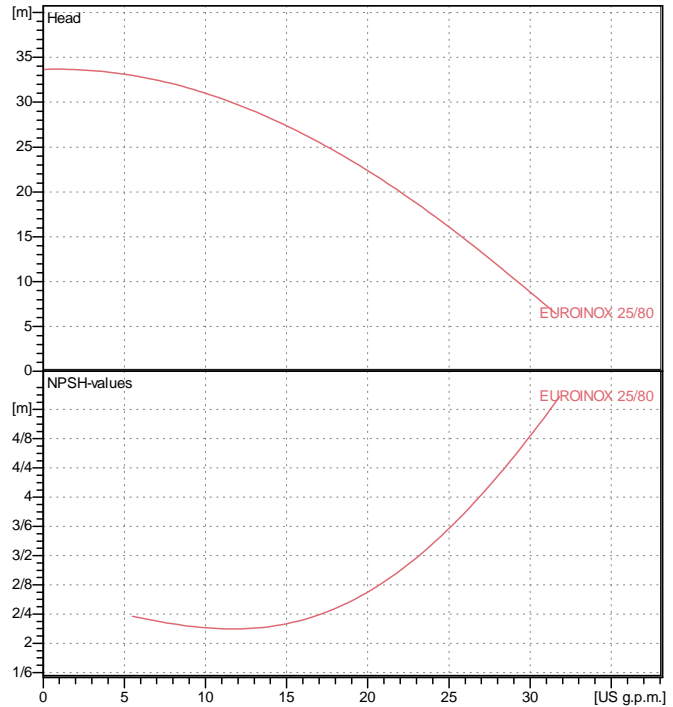
**Curve tolerance according to ISO 9906**

**Motor data**

 Motor brand : DAB  
 Nominal power P2 : 0/55 kW  
 Rated speed : 2800 rpm  
 Rated voltage : 1~ 220-240 V 50 Hz  
 Nominal current : 3/9 A  
 Degree of protection : IP 44

**Weight :** 11/7 kg

**Dimensions in mm**

A	384	DNM	1" NPT	H	300		
B	226	E	186	H1	268		
C	108	F	13/5	H2	143		
DNA	1" NPT	G	111	I?	9		

**Pump connection**

 Suction side : 1" G / 8 bar (800 kPa)  
 Discharge side : 1" G / 8 bar (800 kPa)