

**Receiver**
**From**

 Society  
 Reference  
 Address  
 Phone  
 Fax  
 E-mail

**Item n° :**

102660020

**Model :**

JET 82 M

**Pump data**

 Pressure rating : 6 bar (600 kPa)  
 Min. fluid temperature : 32 °F  
 Max. fluid temperature : 95 °F  
 Max. Ambient temperature : 104 °F

**Priming capacity :**

H	m	2	3	4	5	6	7	8	9
Q	US g.p.m.	12/5	12/2	10/8	10	8/45	7/66	5/81	4/49

**Requested data**

 Flow : 0/00 US g.p.m.  
 Head : 0/00 m  
 Fluid : Water, pure  
 Fluid Temperature : 68 °F  
 Density : 62/322 lb/ft³  
 Kinematic viscosity : 1/0818E-5 ft²/s  
 Vapor pressure : 2/34 kPa

**Hydraulic data (duty point)**

 Flow :  
 Head :

**Materials**

 Pump body : Cast iron 200 UNI ISO 185  
 Support : Die cast aluminium  
 Impeller : Technopoly mer A  
 Mechanical seal : Carbon/Ceramic  
 OR ring : NBR Rubber  
 Shaft with rotor : AISI 416 X12 CrS 13 UNI 6900/71  
 Nozzle venturi dif fuser assembly : Technopoly mer A

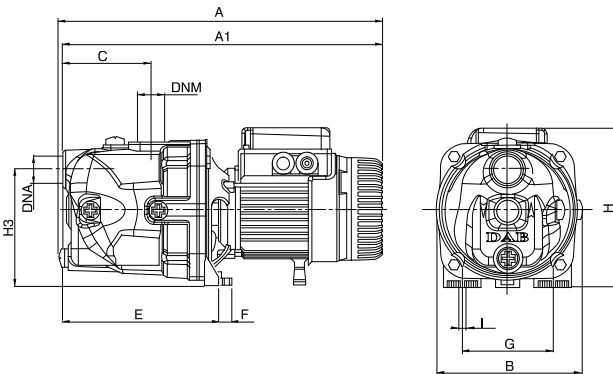
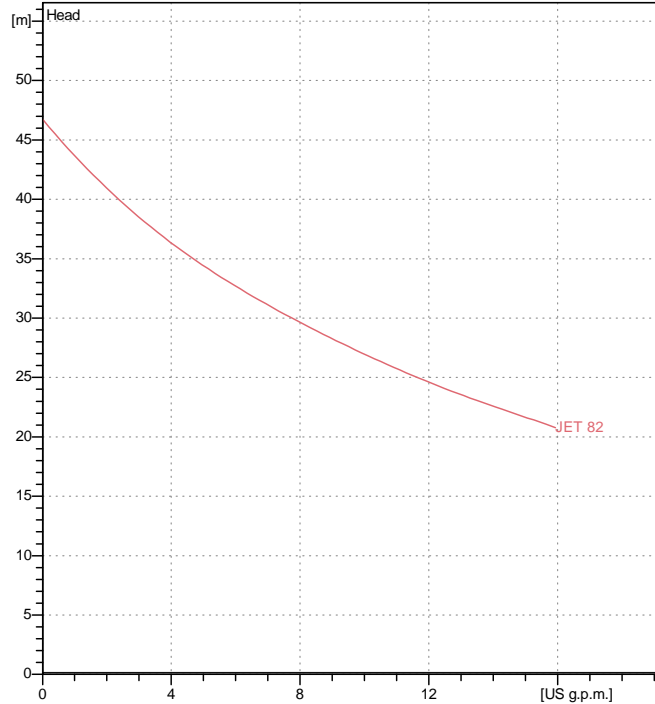
**Curve tolerance according to ISO 9906**

**Motor data**

 Motor brand : DAB  
 Nominal power P2 : 0/6 kW  
 Rated speed : 2750 rpm  
 Rated voltage : 1~ 220-240 V 50 Hz  
 Nominal current : 3/8 A  
 Degree of protection : IP 44

**Dimensions in**
**mm**

A	395	DNA	1" G	G	111		
A1	395	DNM	1" G	H	193		
B	178	E	192	H3	144		
C	108	F	14	I?	9		

**Weight :** 10/7 kg

**Pump connection**

 Suction side : 1 " G / 6 bar (600 kPa)  
 Discharge side : 1 " G / 6 bar (600 kPa)