

Receiver
From

 Society
 Reference
 Address
 Phone
 Fax
 E-mail

Item n° :

105110434

Model :

KLP 40/1200 M

Pump data

 MEI \geq 0,40

Pressure rating : PN6 (4 slotted holes), PN10 (4 holes)

Min. fluid temperature : 5 °F

Max. fluid temperature : 248 °F

Max. Ambient temperature : 104 °F

Requested data

Flow : 0/00 US g.p.m.

Head : 0/00 m

Fluid (%) : Water, pure

Fluid Temperature : 68 °F

 Density : 62/322 lb/ft³

 Kinematic viscosity : 1/0818E-5 ft²/s

Vapor pressure : 2/34 kPa

Hydraulic data (duty point)

Flow :

Head :

NPSH :

Shaft power P2 :

Efficiency :

Materials

Pump body : Cast iron 250 UNI ISO 185

Support : Cast iron 250 UNI ISO 185

Impeller : Technopolymer B

Mechanical seal : Carbon/Ceramic

OR ring : EPDM Rubber

Shaft with rotor : AISI 303 X10 CrNiS 1809 UNI 6900/71

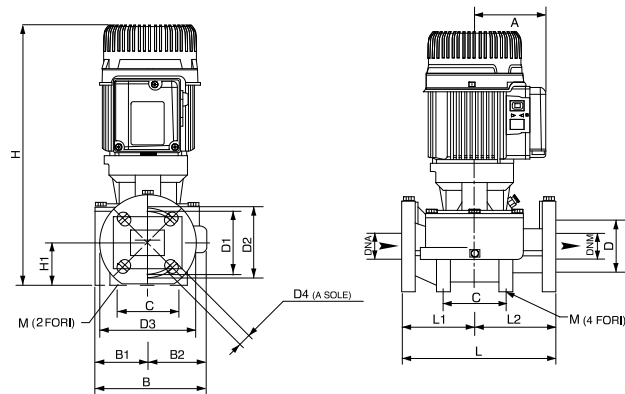
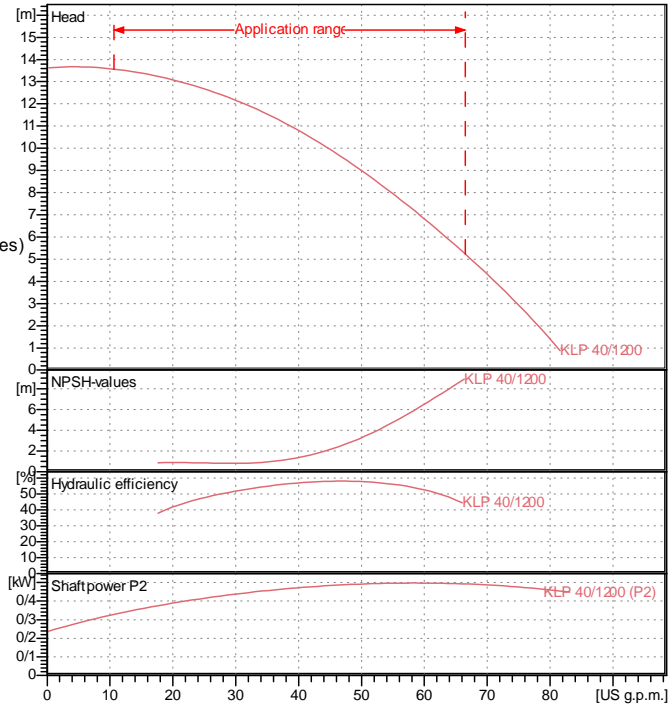
Curve tolerance according to ISO 9906

Weight : 23/2 kg

Dimensions in mm

A	110	D2	110	L	250
B	179	D3	150	L1	125
B1	82	D4	4 asole 18x23	L2	125
B2	97	DNA	40	M	2 fori 10
C	100	DNM	40		
D	80	H	395		
D1	100	H1	66		

Pump connection

Suction side : DN 40 / PN6 (4 slotted holes), PN10 (4 holes)

Discharge side : DN 40 / PN6 (4 slotted holes), PN10 (4 holes)

Motor data

Motor brand : DAB

Nominal power P2 : 0/55 kW

Rated speed : 2920 rpm

Rated voltage : 1~ 220-240 V 50 Hz

Nominal current : 3/4 A

Degree of protection : IP 55