

Receiver
From

 Society
 Reference
 Address
 Phone
 Fax
 E-mail

Item n° :

60180067

Model :

CM 40-1300 T IE3

Pump data

 MEI \geq 0,40

 Pressure rating : PN 16
 Min. fluid temperature : 14 °F
 Max. fluid temperature : 266 °F
 Max. Ambient temperature : 104 °F

Requested data

 Flow : 0/00 US g.p.m.
 Head : 0/00 m
 Fluid (%) : Water, pure
 Fluid Temperature : 68 °F
 Density : 62/322 lb/ft³
 Kinematic viscosity : 1/0818E-5 ft²/s
 Vapor pressure : 2/34 kPa

Hydraulic data (duty point)

 Flow :
 Head :
 NPSH :
 Shaft power P2 :
 Efficiency :

Materials

 Pump body : Cast iron 250 UNI ISO 185
 Support : Cast iron 250 UNI ISO 185
 Impeller : Cast iron 250 UNI ISO 185
 Mechanical seal : Carbon/Graphite
 OR ring : EPDM Rubber
 Shaft with rotor : AISI 304 X5 Cr Ni 1810 UNI 6900/71

Motor data

 Nominal power P2 : 0/75 kW
 Rated speed : 1450 rpm
 Rated voltage : 3~ 230 V / 400 V 50 Hz
 Nominal current : 3/3 / 1/9 A
 Degree of protection : IP 55

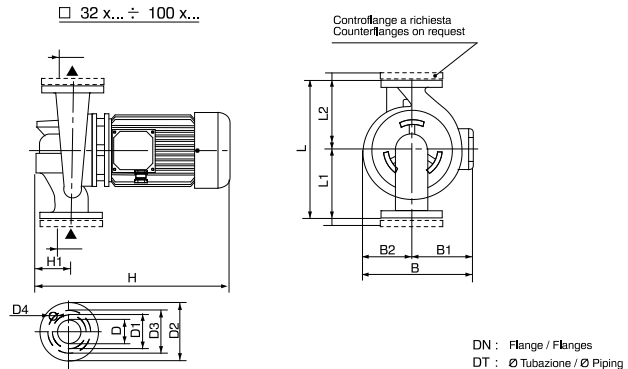
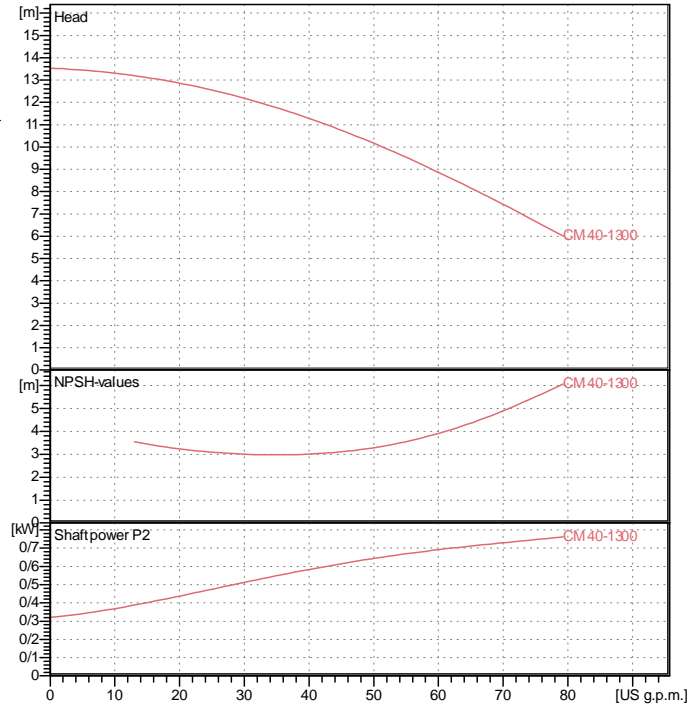
Curve tolerance according to ISO 9906

Weight : 30 kg

Dimensions in mm

B	245	D4	4 x ?18
B1	118	H	445
B2	127	H1	100
D	40 PN 16	L	380
D1	88	L1	200
D2	150	L2	180
D3	110		

Pump connection

 Suction side : DN 40 / PN 16
 Discharge side : DN 40 / PN 16