

Receiver
From

 Society
 Reference
 Address
 Phone
 Fax
 E-mail

Item n° :

60179897

Model :

CP 50/2200 T IE3

Pump data

 MEI \geq 0,60

 Pressure rating : PN 16
 Min. fluid temperature : 14 °F
 Max. fluid temperature : 266 °F
 Max. Ambient temperature : 104 °F

Requested data

 Flow : 0/00 US g.p.m.
 Head : 0/00 m
 Fluid (%) : Water, pure
 Fluid Temperature : 68 °F
 Density : 62/322 lb/ft³
 Kinematic viscosity : 1/0818E-5 ft²/s
 Vapor pressure : 2/34 kPa

Hydraulic data (duty point)

 Flow :
 Head :
 NPSH :
 Shaft power P2 :
 Efficiency :

Materials

 Pump body : Cast iron 250 UNI ISO 185
 Support : Cast iron 250 UNI ISO 185
 Impeller : Technopoly mer B
 Mechanical seal : Carbon/Graphite
 OR ring : EPDM Rubber
 Shaft with rotor : AISI 304 X5 Cr Ni 1810 UNI 6900/71

Motor data

 Nominal power P2 : 1/1 kW
 Rated speed : 2906 rpm
 Rated voltage : 3~ 230 V / 400 V 50 Hz
 Nominal current : 5/8 / 3/4 A
 Degree of protection : IP 55

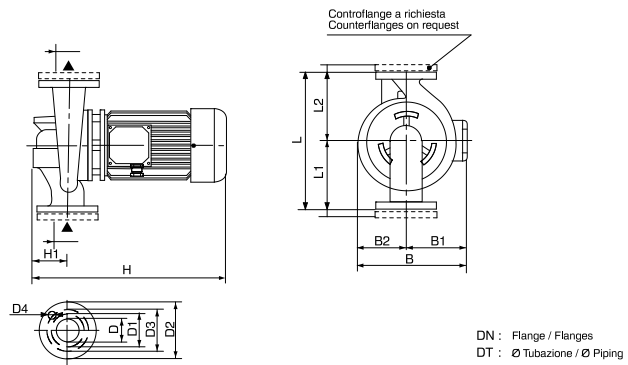
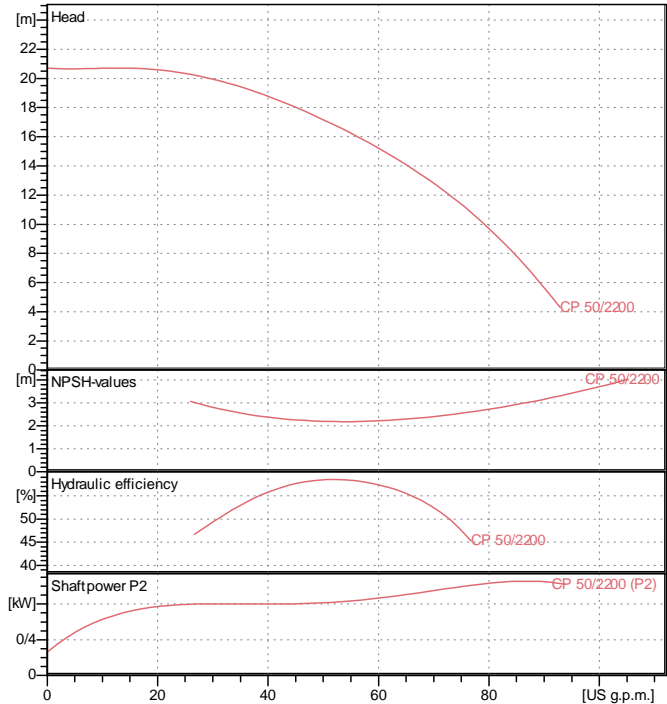
Curve tolerance according to ISO 9906

Weight : 40 kg

Dimensions in mm

B	233	D4	4 x ?18		
B1	120	H	463		
B2	113	H1	105		
D	50 PN16	L	425		
D1	102	L1	225		
D2	165	L2	200		
D3	125				

Pump connection

 Suction side : DN 50 / PN 16
 Discharge side : DN 50 / PN 16