

**Receiver**
**From**

 Society  
 Reference  
 Address  
 Phone  
 Fax  
 E-mail

**Item n° :**

505814041

**Model :**

B 56/250.40 M

**Pump data**

 Pressure rating : PN 10  
 Min. fluid temperature : 14 °F  
 Max. fluid temperature : 230 °F

**Minimum suction head :**

 Temperature °F 194  
 Minimum suction head : m 2/5

**Requested data**

 Flow : 0/00 US g.p.m.  
 Head : 0/00 m  
 Fluid (%) : Water, pure  
 Fluid Temperature : 68 °F  
 Density : 62/322 lb/ft³  
 Kinematic viscosity : 1/0818E-5 ft²/s  
 Vapor pressure : 2/34 kPa

**Hydraulic data (duty point)**

 Flow :  
 Head :  
 Rated speed : 2636 rpm

**Materials**

 Pump body : Cast iron  
 Impeller : Technopolymer  
 Motor shaft : Stainless steel  
 Air vent plug : Brass  
 Seal ring : Etyilene propylene  
 Motor casing : Die cast aluminium  
 Stator jacket : Stainless steel

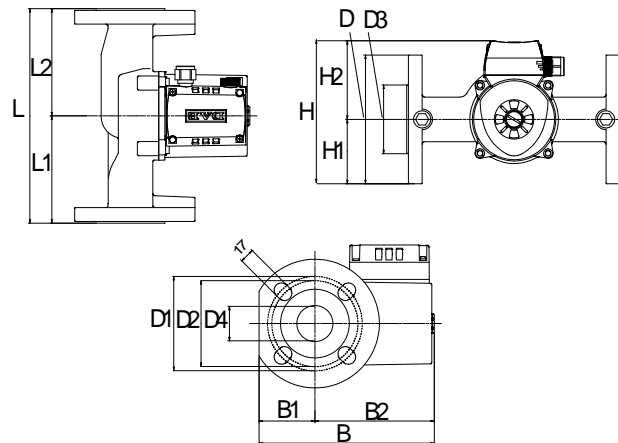
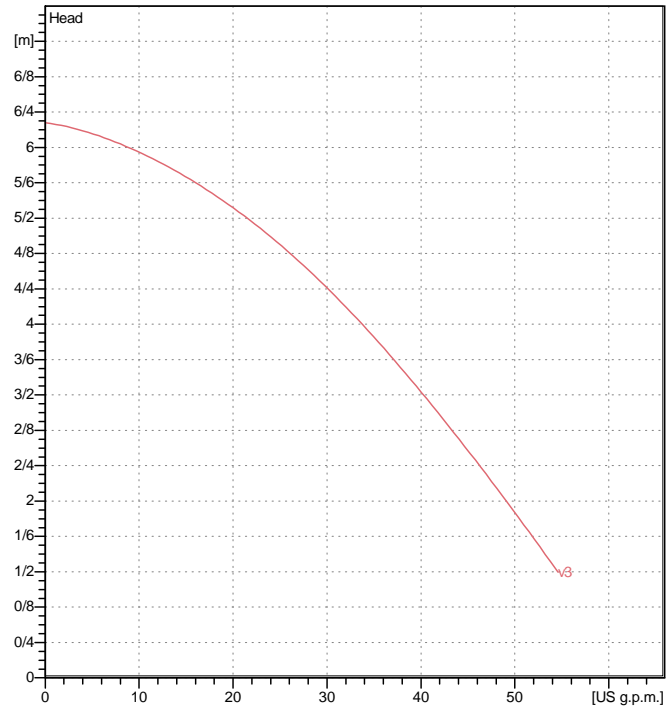
**Curve tolerance according to ISO 9906**

**Motor data**

 Motor brand : DAB  
 Nominal power P2 : 0/2032 kW  
 Rated speed : 2658 rpm  
 Rated voltage : 1~ 230 V 50 Hz  
 Nominal current : 1/18 A  
 Degree of protection : IP 44

**Dimensions in mm**

B	204	D1	110	F	DN40/PN10	250
B1	65	D2	100	H	167	L1 125
B2	139	D3	80	H1	75	L2 125
D	150	D4	40	H2	92	

**Weight :** 8/6 kg

**Pump connection**

 Suction side : DN 40 / PN 10  
 Discharge side : DN 40 / PN 10