

Receiver
From

 Society
 Reference
 Address
 Phone
 Fax
 E-mail

Item n° :

505812671

Model :

B 50/250.40 T

Pump data

 Pressure rating : PN 10
 Min. fluid temperature : 14 °F
 Max. fluid temperature : 230 °F

Minimum suction head :

 Temperature °F 194
 Minimum suction head : m 2/5

Requested data

 Flow : 0/00 US g.p.m.
 Head : 0/00 m
 Fluid (%) : Water, pure
 Fluid Temperature : 68 °F
 Density : 62/322 lb/ft³
 Kinematic viscosity : 1/0818E-5 ft²/s
 Vapor pressure : 2/34 kPa

Hydraulic data (duty point)

 Flow :
 Head :
 Rated speed : 2827 rpm

Materials

 Pump body Cast iron
 Impeller Technopolymer
 Motor shaft Stainless steel
 Air vent plug Brass
 Seal ring Etyilene propylene
 Motor casing Die cast aluminium
 Stator jacket Stainless steel

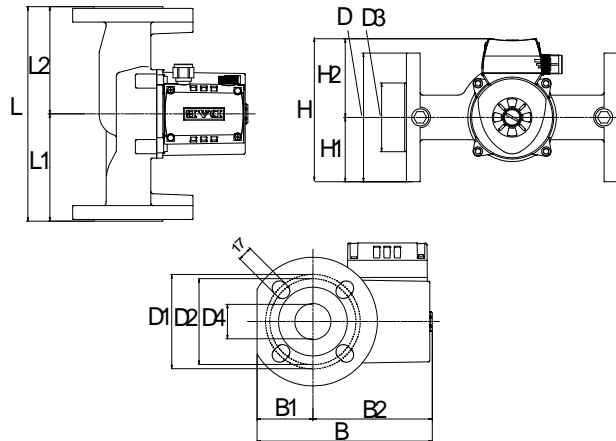
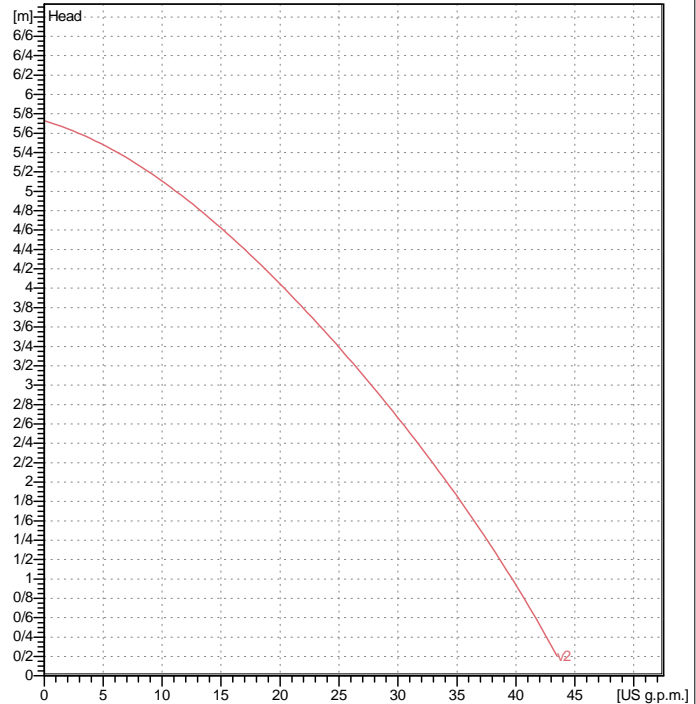
Curve tolerance according to ISO 9906

Motor data

 Motor brand : DAB
 Nominal power P2 : 0/1507 kW
 Rated speed : 2838 rpm
 Rated voltage : 3~ 400 V 50 Hz
 Nominal current : 0/5 A
 Degree of protection : IP 44

Dimensions in mm

B	204	D1	110	F	DN40/PN10	250
B1	65	D2	100	H	167	L1 125
B2	139	D3	80	H1	75	L2 125
D	150	D4	40	H2	92	

Weight : 8/8 kg

Pump connection

 Suction side : DN 40 / PN 10
 Discharge side : DN 40 / PN 10