

Receiver
From

 Society
 Reference
 Address
 Phone
 Fax
 E-mail

Item n° :

60112902

Model :

VA 25/180 X

Pump data

Pressure rating : 10 bar (1000 KPa)

Min. fluid temperature : 14 °F

Max. fluid temperature : 230 °F

Minimum suction head :

Temperature °F

Minimum suction head : m

Requested data

Flow : 0/00 US g.p.m.

Head : 0/00 m

Fluid (%) : Water, pure

Fluid Temperature : 68 °F

Density : 62/322 lb/ft³

Kinematic viscosity : 1/0818E-5 ft²/s

Vapor pressure : 2/34 kPa

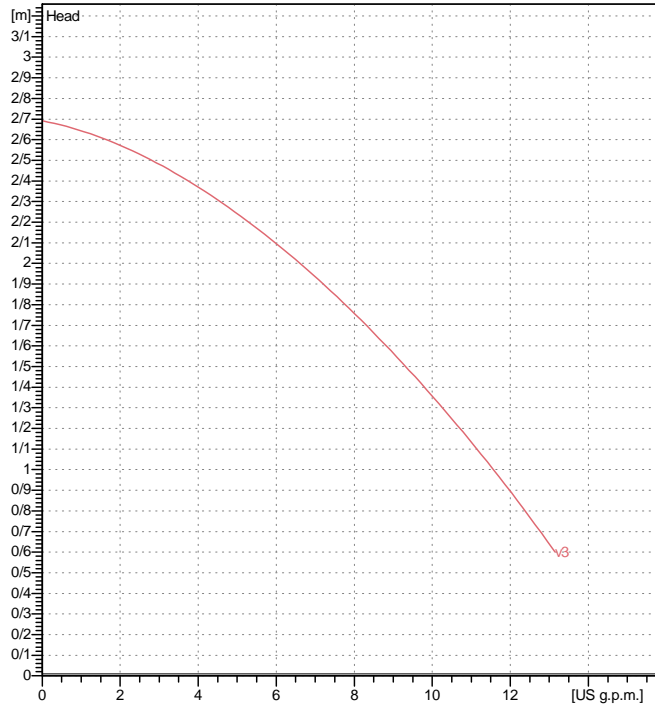
Curve tolerance according to ISO 9906

Hydraulic data (duty point)

Flow :

Head :

Materials

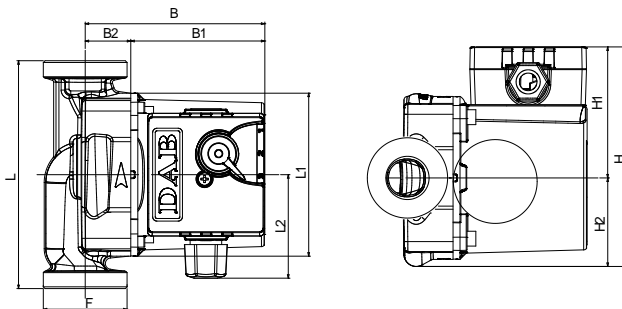
Pump body	Cast iron
Impeller	Technopolymer
Motor shaft	Stainless steel
Air vent plug	Brass
Seal ring	Etyilene propylene
Motor casing	Die cast aluminium
Stator jacket	Stainless steel

Motor data

Motor brand : DAB

Power input P1 : 0/043 kW

Rated speed : 2655 rpm

Rated voltage : 1~ 230 V 50 Hz

Nominal current : 0/19 A

Degree of protection : IP 44

Dimensions in mm

B	104	H	124	L1	98		
B1	78	H1	75	L2	60		
B2	26	H2	49				
F	2"	L	180				

Weight : 2/6 kg

Pump connection

Suction side : 2" G / 10 bar (1000 KPa)

Discharge side : 2" G / 10 bar (1000 KPa)