

Receiver
From

 Society
 Reference
 Address
 Phone
 Fax
 E-mail

Item n° :

505806671

Model :

A 80/180 XT

Pump data

Pressure rating : 10 bar (1000 KPa)

Min. fluid temperature : 14 °F

Max. fluid temperature : 230 °F

Minimum suction head :

Temperature °F 194

Minimum suction head : m 2/5

Requested data

Flow : 0/00 US g.p.m.

Head : 0/00 m

Fluid (%) : Water, pure

Fluid Temperature : 68 °F

Density : 62/322 lb/ft³

Kinematic viscosity : 1/0818E-5 ft²/s

Vapor pressure : 2/34 kPa

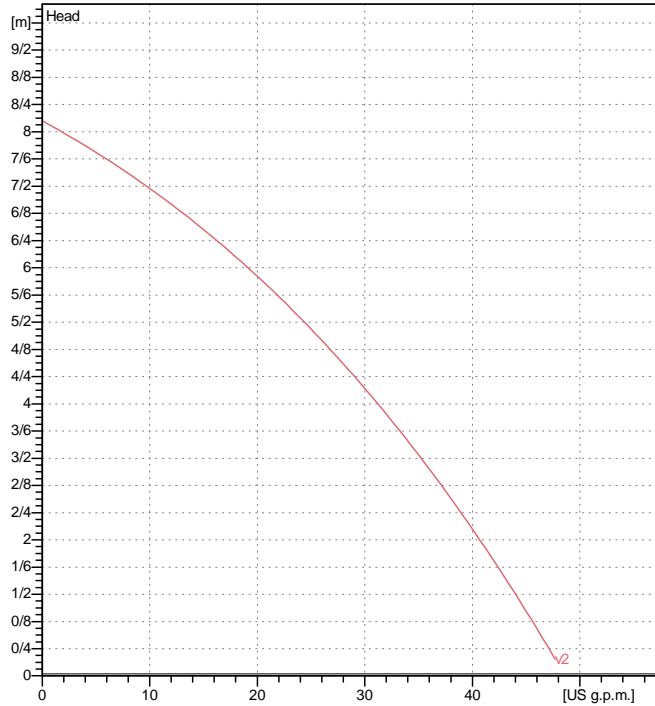
Curve tolerance according to ISO 9906

Hydraulic data (duty point)

Flow :

Head :

Materials

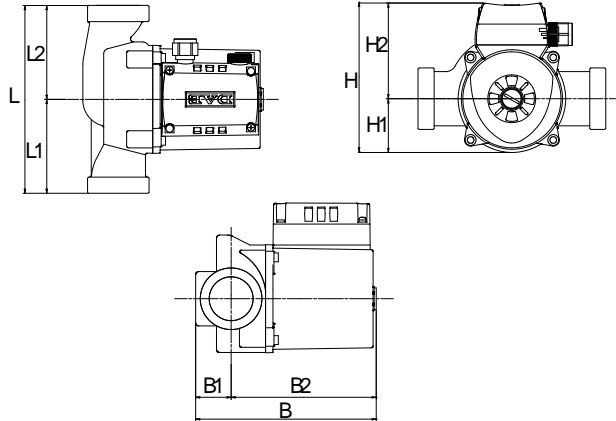
Pump body	Cast iron
Impeller	Technopolymer
Motor shaft	Stainless steel
Air vent plug	Brass
Seal ring	Etyilene propylene
Motor casing	Die cast aluminium
Stator jacket	Stainless steel

Motor data

Motor brand : DAB

Power input P1 : 0/272 kW

Rated speed : 2727 rpm

Rated voltage : 3~ 400 V 50 Hz

Nominal current : 0/57 A

Degree of protection : IP 44

Dimensions in mm

B	173	H	143	L1	90		
B1	34	H1	52	L2	90		
B2	139	H2	92				
F	2"G	L	180				

Weight : 5 kg

Pump connection

 Suction side : 2 " / 10 bar (1000 KPa)
 Discharge side : 2 " / 10 bar (1000 KPa)