

**Receiver**
**From**

 Society  
 Reference  
 Address  
 Phone  
 Fax  
 E-mail

**Item n° :**

505805601

**Model :**

A 56/180 T

**Pump data**

Pressure rating : 10 bar (1000 KPa)

Min. fluid temperature : 14 °F

Max. fluid temperature : 230 °F

**Minimum suction head :**

Temperature °F 194

Minimum suction head : m 1/5

**Requested data**

Flow : 0/00 US g.p.m.

Head : 0/00 m

Fluid (%) : Water, pure

Fluid Temperature : 68 °F

Density : 62/322 lb/ft³

Kinematic viscosity : 1/0818E-5 ft²/s

Vapor pressure : 2/34 kPa

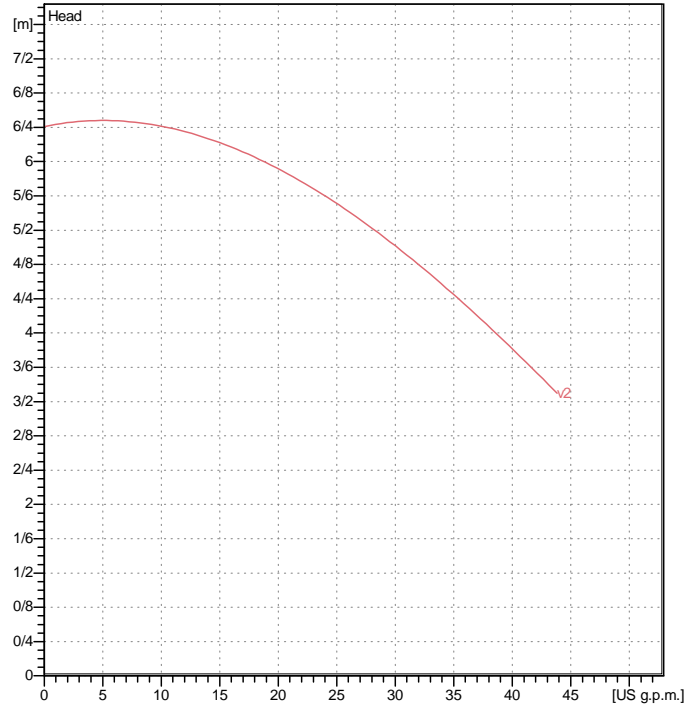
**Curve tolerance according to ISO 9906**

**Hydraulic data (duty point)**

Flow :

Head :

**Materials**

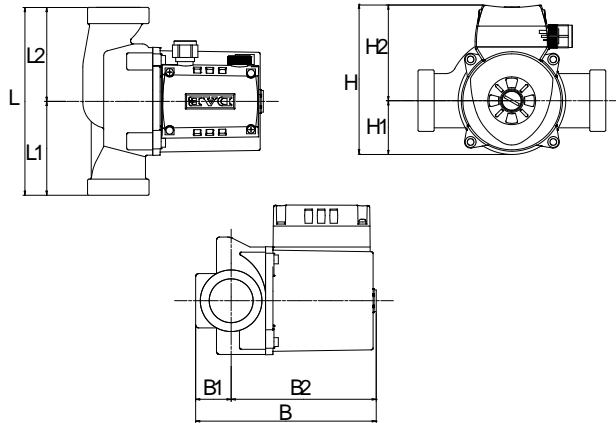
Pump body	Cast iron
Impeller	Technopolymer
Motor shaft	Stainless steel
Air vent plug	Brass
Seal ring	Etyilene propylene
Motor casing	Die cast aluminium
Stator jacket	Stainless steel

**Motor data**

Motor brand : DAB

Power input P1 : 0/294 kW

Rated speed : 2704 rpm

Rated voltage : 3~ 400 V

50 Hz

Nominal current : 0/6 A

Degree of protection : IP 44

**Dimensions in mm**

B	173	H	143	L1	90		
B1	34	H1	52	L2	90		
B2	139	H2	92				
F	1"1/2	L	180				

**Weight :** 5 kg

**Pump connection**

Suction side : 1 " 1/2 / 10 bar (1000 KPa)

Discharge side : 1 " 1/2 / 10 bar (1000 KPa)