

**Receiver**
**From**

 Society  
 Reference  
 Address  
 Phone  
 Fax  
 E-mail

**Item n° :**

505809001

**Model :**

A 110/180 XM

**Pump data**

Pressure rating : 10 bar (1000 KPa)

Min. fluid temperature : 14 °F

Max. fluid temperature : 230 °F

**Minimum suction head :**

Temperature °F 194

Minimum suction head : m 2/5

**Requested data**

Flow : 0/00 US g.p.m.

Head : 0/00 m

Fluid (%) : Water, pure

Fluid Temperature : 68 °F

Density : 62/322 lb/ft³

Kinematic viscosity : 1/0818E-5 ft²/s

Vapor pressure : 2/34 kPa

**Curve tolerance according to ISO 9906**

**Hydraulic data (duty point)**

Flow :

Head :

**Materials**

Pump body	Cast iron
Impeller	Technopolymer
Motor shaft	Stainless steel
Air vent plug	Brass
Seal ring	Etyilene propylene
Motor casing	Die cast aluminium
Stator jacket	Stainless steel

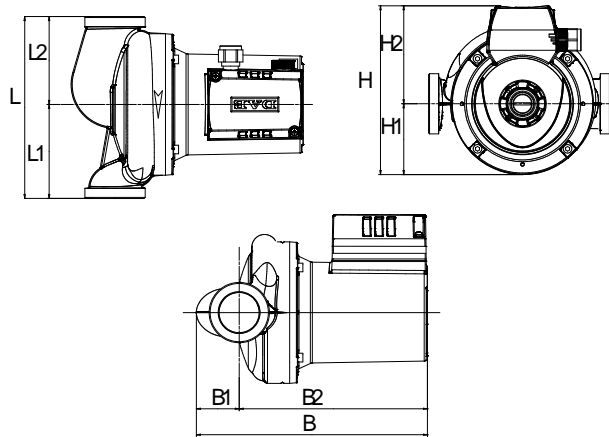
**Motor data**

Motor brand : DAB

Power input P1 : 0/41 kW

Rated speed : 2746 rpm

Rated voltage : 1~ 230 V 50 Hz

Nominal current : 1/77 A

Degree of protection : IP 44

**Dimensions in mm**

B	229	H	167	L1	93
B1	42	H1	70	L2	87
B2	186	H2	97		
F	2"G	L	180		

**Weight :** 7/5 kg

**Pump connection**

Suction side : 2 " / 10 bar (1000 KPa)

Discharge side : 2 " / 10 bar (1000 KPa)