

Receiver
From

 Society
 Reference
 Address
 Phone
 Fax
 E-mail

Item n° :

505928622

Model :

BPH 150/280.50 T

Pump data

 Pressure rating : PN 10
 Min. fluid temperature : 14 °F
 Max. fluid temperature : 248 °F

Minimum suction head :

Temperature	°F	167	194	230	248
Minimum suction head :	m	2	5	--	20

Requested data

 Flow : 0/00 US g.p.m.
 Head : 0/00 m
 Fluid (%) : Water, pure
 Fluid Temperature : 68 °F
 Density : 62/322 lb/ft³
 Kinematic viscosity : 1/0818E-5 ft²/s
 Vapor pressure : 2/34 kPa

Hydraulic data (duty point)

 Flow :
 Head :

Materials

Pump body	Cast iron 200 UNI ISO 185
Impeller	Technopolymer B
Motor shaft	AISI 420 C
Air vent plug	Brass P Cu Zn40 Pb2 UNI 5705
Seal ring	Ethylene propylene (EPDM)
Motor casing	Die cast aluminium
Stator jacket	AISI 321Bon. - AISI 304

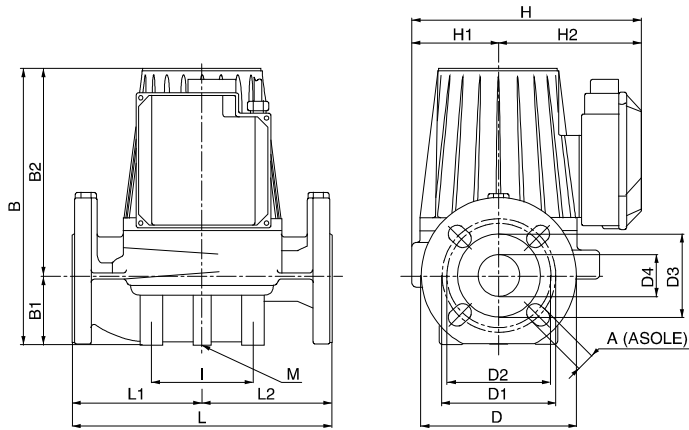
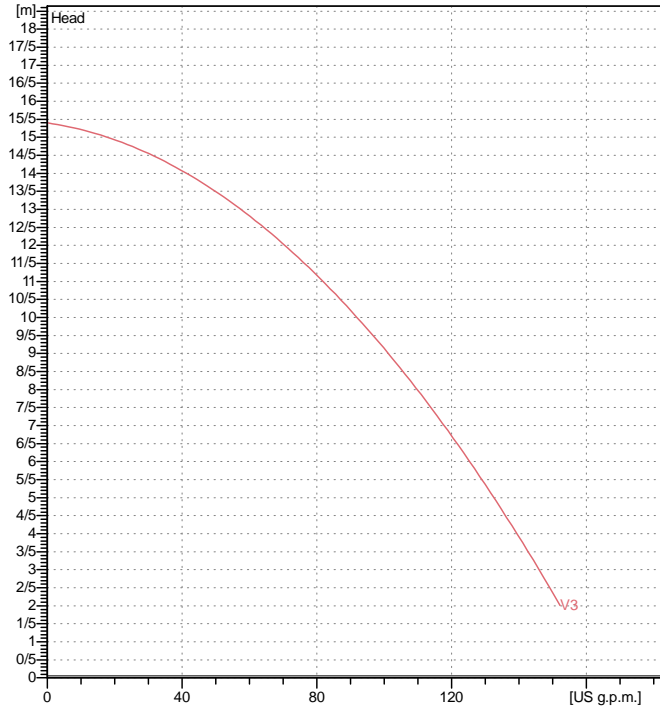
Curve tolerance according to ISO 9906

Motor data

Motor brand :	DAB	
Power input P1 :	1/469 kW	
Rated speed :	2850 rpm	
Rated voltage :	3~ 400 V	50 Hz
Nominal current :	2/9 A	
Degree of protection :	IP 44	

Dimensions in mm

A	18	D	165	D4	50	I	100
B	362	D1	125	H	254	I1	-
B1	73	D2	110	H1	96	I2	-
B2	289	D3	90	H2	158	I3	-

Weight : 26 kg

Pump connection

 Suction side : DN 50 / PN 10
 Discharge side : DN 50 / PN 10