

Receiver
From

 Society
 Reference
 Address
 Phone
 Fax
 E-mail

Item n° :

60179867

Model :

KVC 60/120 T IE3

Pump data

 MEI \geq 0,50

Pressure rating : 12 bar (1200 KPa)

Min. fluid temperature : 32 °F

Max. fluid temperature : 104 °F

Max. Ambient temperature : 104 °F

Requested data

Flow : 0/00 US g.p.m.

Head : 0/00 m

Fluid : Water, pure

Fluid Temperature : 68 °F

 Density : 62/322 lb/ft³

 Kinematic viscosity : 1/0818E-5 ft²/s

Vapor pressure : 2/34 kPa

Hydraulic data (duty point)

Flow :

Head :

NPSH :

Shaft power P2 : 2/20 kW

Efficiency : - %

Materials

Impeller Technopoly mer B

Diff user Technopoly mer B

Shaft with rotor AISI 303 X10 CrNiS 1809 UNI 6900/71

External sleeve AISI 304 X5 Cr Ni 1810 UNI 6900/71

Seal disk AISI 304 X5 Cr Ni 1810 UNI 6900/71

Mechanical seal Silicon carbide/Carbon

OR ring EPDM Rubber

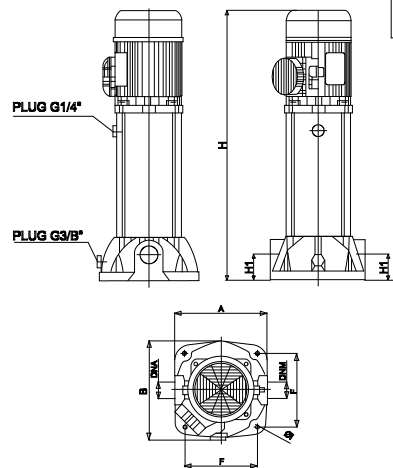
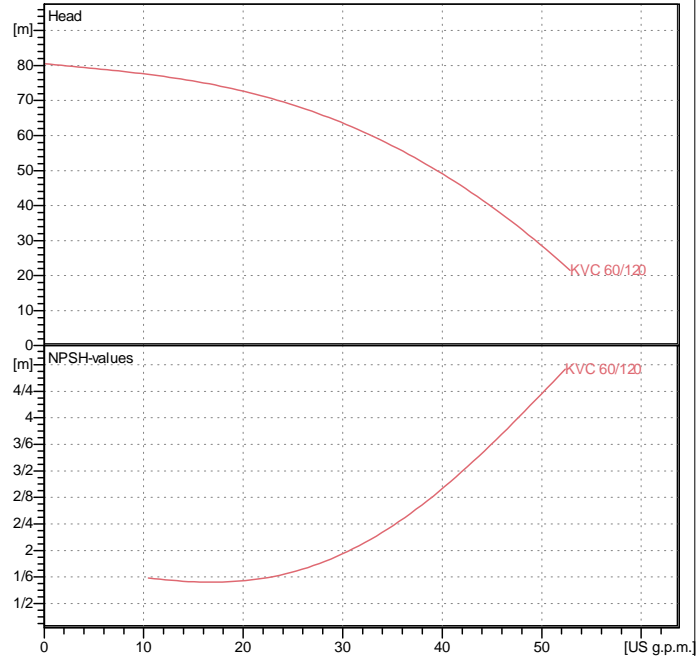
Curve tolerance according to ISO 9906

Weight : 21/6 kg

Motor data

Motor brand : DAB

Nominal power P2 : 2/2 kW

Rated speed : 2800 rpm

Rated voltage : 3~ 400 V / 230 V 50 Hz

Nominal current : 5/4 / 9/3 A

Degree of protection : IP 55

Dimensions in mm

? I	9
A	221
B	235
DNA	1"1/4 G
DNM	1"1/4 G
F	170
H	610
H1	60

Pump connection

Suction side : 1 " 1/4 G 12 bar (1200 KPa)

Discharge side : 1 " 1/4 G 12 bar (1200 KPa)