	<b>Product information</b> <b>TD80-48G/2</b>	Manufacturer	CNP
		Address	Yuhang District, Hangzhou,
<b>Project Name</b>		Contact	86-571-88637351
		Date	2022/03/09
<b>Station Number</b>		Client Name	DPA
		Client Addr.	
		Contacts	Alireza
		Contact	

Product No.	1100077560
-------------	------------

Product picture(Note:the picture may not be the same as the	Series description
	<p><b>Product introduction</b></p> <p>Single stage in-line centrifugal pumps,inlet and outlet are horizontal with top side pulled out structure and can be repaired without removing the pipelines.</p> <p><b>Performance and advantages</b></p> <p>Compact structure  Maintenance convenience  Low noise  Both cast iron and stainless steel impeller are available</p> <p><b>Application range</b></p>

<b>technology</b>	
Pump rotator speed	2900
Pump version	Extension shaft
<b>Material</b>	
Impeller	HT200
Pump body	HT200
Rubber code	NBR
<b>Installation</b>	
Connection Code	F
Maximum Operation Pressure	PN12
<b>Medium</b>	
Medium Temperature	-15~110
<b>Structure dimension</b>	
Inlet & outlet size types	DN
Inlet & Outlet Bore	80
Rotation Direction	Clockwise rotation viewed from motor end
<b>Motor</b>	
Number of Motor Phase	Three Phase
Protection Class	IP55
Insulation Class	F
Motor Power	15
Power Frequency	50Hz
Rated Voltage (V)	380V
Energy Efficiency Level	IE3
<b>Seal</b>	
Mechanical Seal	TDS-28/BSE4
<b>Others</b>	
Weight (kg)	191



# Performance Curve TD80-48G/2

Manufacturer	CNP
Address	Yuhang District, Hangzhou,
Contact	86-571-88637351
Date	2022/03/09
Client Name	DPA
Client Addr.	
Contacts	Alireza
Contact	

Project Name

Station Number

Medium Name Clear Water , Temperature 20°C, Density 1000kg/m<sup>3</sup>, Viscosity 1mm<sup>2</sup>/s, (ISO99062012 Grande 3B)

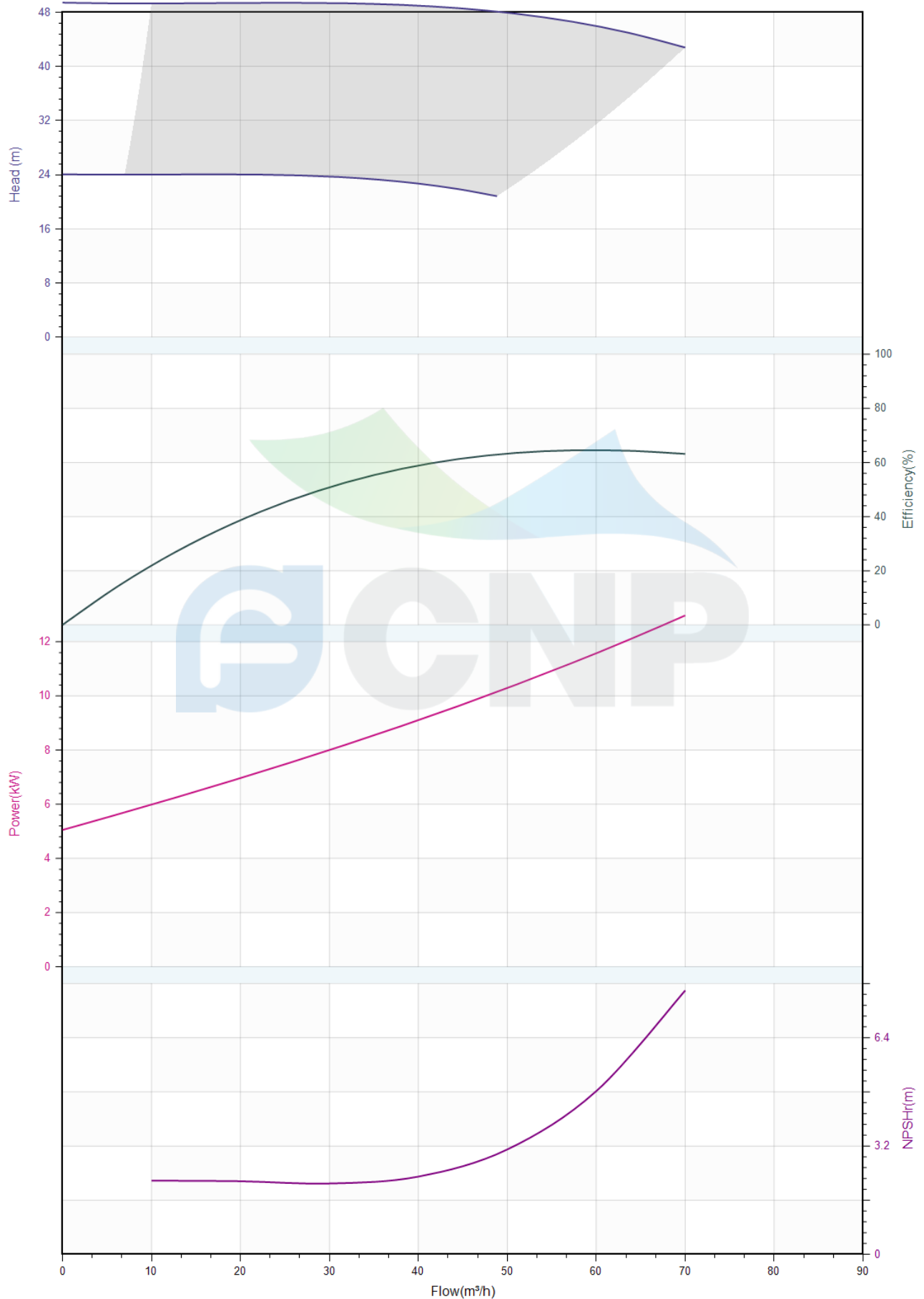



## Pump technical parameters TD80-48G/2

Manufacturer	CNP
Address	Yuhang District, Hangzhou,
Contact	86-571-88637351
Date	2022/03/09
Client Name	DPA
Client Addr.	
Contacts	Alireza
Contact	

### Rated parameters

Pump model	TD80-48G/2
Product No.	1100077560
Rated flow(m <sup>3</sup> /h)	50
Rated pressure(m)	48
Rated efficiency(%)	63
Power(kW)	10.38
NPSHr(m)	3
Speed(rpm)	2900
Max impeller diameter(mm)	192

### Medium

Medium Name	Clear Water
Working temperature(°C)	20
Medium density(kg/m <sup>3</sup> )	1000
Viscosity(mm <sup>2</sup> /s)	1

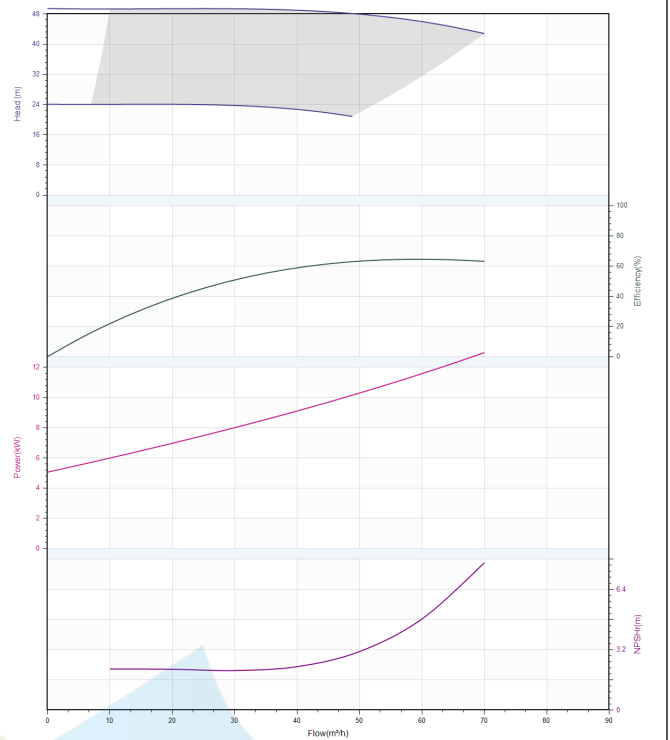



**Structure picture**  
**TD80-48G/2**

Manufacturer	CNP
Address	Yuhang District, Hangzhou,
Contact	86-571-88637351
Date	2022/03/09
Client Name	DPA
Client Addr.	
Contacts	Alireza
Contact	

Project Name	
Station Number	

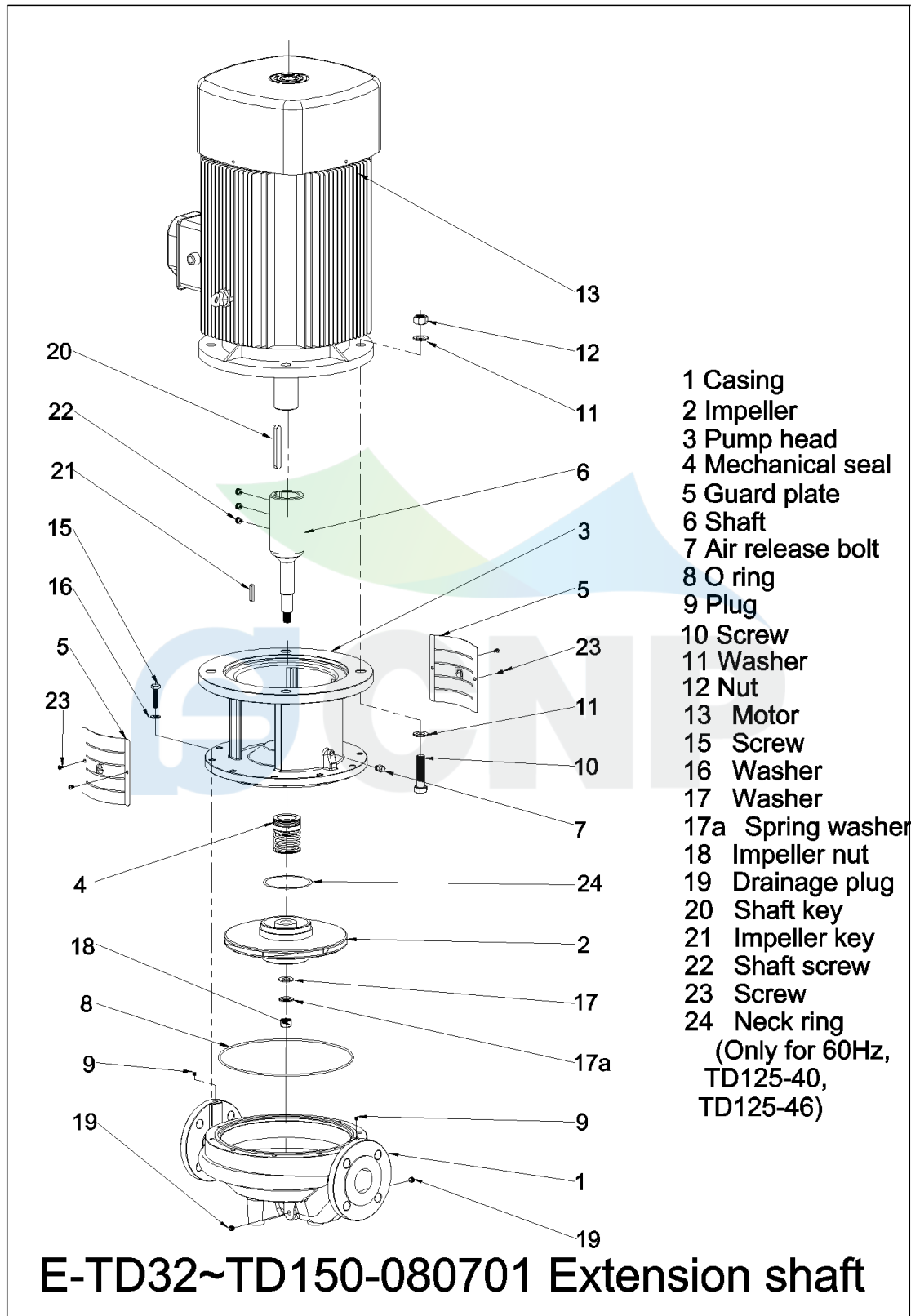



Size picture  
TD80-48G/2

Manufacturer	CNP
Address	Yuhang District, Hangzhou,
Contact	86-571-88637351
Date	2022/03/09
Client Name	DPA
Client Addr.	
Contacts	Alireza
Contact	

Project Name

Station Number

