	Product information TD65-40/2	Manufacturer	CNP
		Address	Yuhang District, Hangzhou,
Project Name		Contact	86-571-88637351
		Date	2022/03/09
Station Number		Client Name	DPA
		Client Addr.	
		Contacts	Alireza
		Contact	

Product No.	1100042382
-------------	------------

Product picture(Note:the picture may not be the same as the	Series description
	<p>Product introduction</p> <p>Single stage in-line centrifugal pumps,inlet and outlet are horizontal with top side pulled out structure and can be repaired without removing the pipelines.</p> <p>Performance and advantages</p> <p>Compact structure Maintenance convenience Low noise Both cast iron and stainless steel impeller are available</p> <p>Application range</p>

technology	
Pump rotator speed	2900
Pump version	Extension shaft
Material	
Impeller	HT200
Pump body	HT200
Rubber code	NBR
Installation	
Connection Code	F
Maximum Operation Pressure	PN12
Medium	
Medium Temperature	-15~110
Structure dimension	
Inlet & outlet size types	DN
Inlet & Outlet Bore	65
Rotation Direction	Clockwise rotation viewed from motor end
Motor	
Number of Motor Phase	Three Phase
Protection Class	IP55
Insulation Class	F
Motor Power	11
Power Frequency	50Hz
Rated Voltage (V)	380V
Energy Efficiency Level	IE3
Seal	
Mechanical Seal	TD-28/B2SE4
Others	
Weight (kg)	183



Performance Curve TD65-40/2

Manufacturer	CNP
Address	Yuhang District, Hangzhou,
Contact	86-571-88637351
Date	2022/03/09
Client Name	DPA
Client Addr.	
Contacts	Alireza
Contact	

Project Name

Station Number

Medium Name Clear Water , Temperature 20°C, Density 1000kg/m³, Viscosity 1mm²/s, (ISO99062012 Grande 3B)

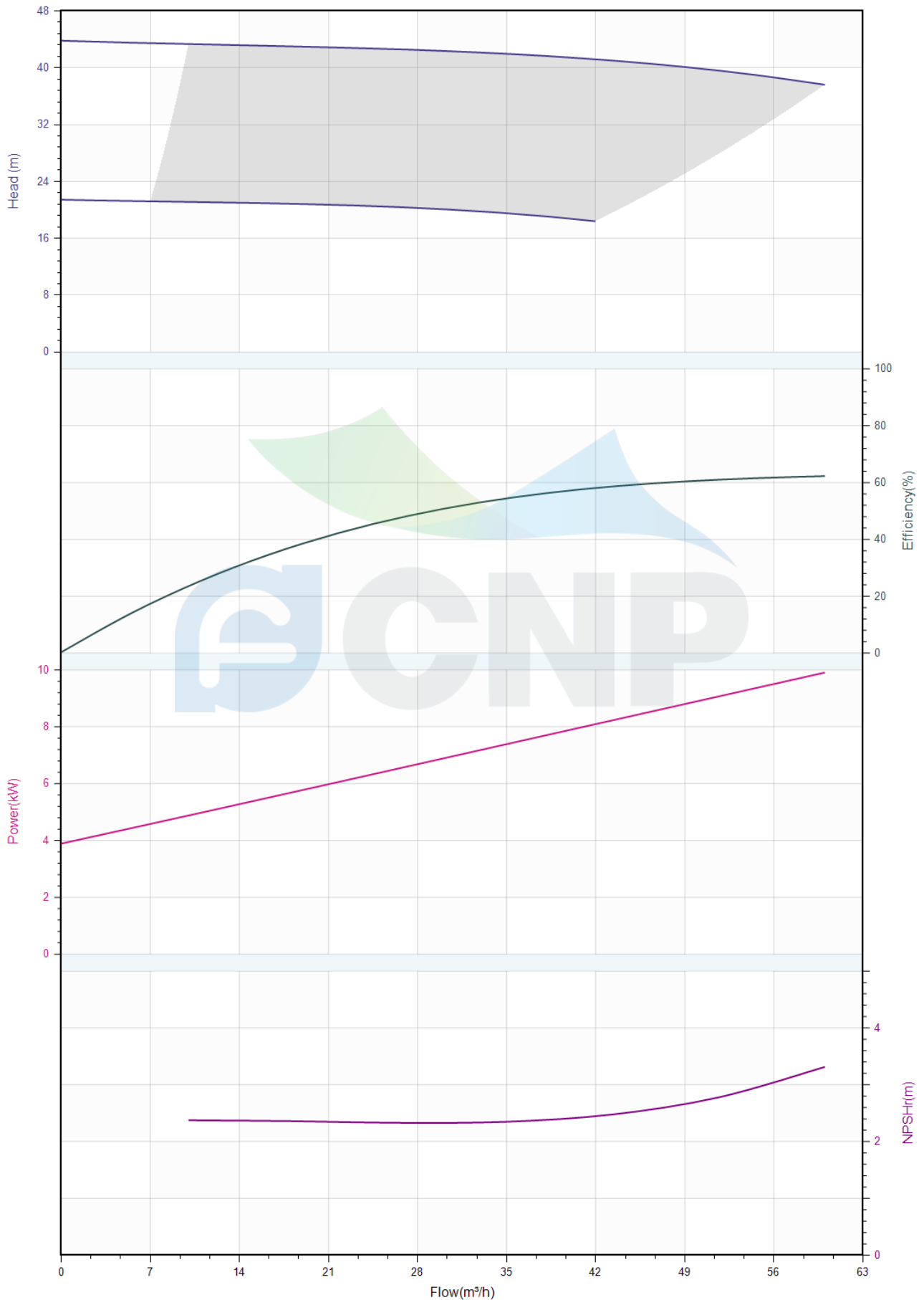



Pump technical parameters TD65-40/2

Manufacturer	CNP
Address	Yuhang District, Hangzhou,
Contact	86-571-88637351
Date	2022/03/09
Client Name	DPA
Client Addr.	
Contacts	Alireza
Contact	

Rated parameters

Pump model	TD65-40/2
Product No.	1100042382
Rated flow(m ³ /h)	50
Rated pressure(m)	40
Rated efficiency(%)	64
Power(kW)	8.52
NPSHr(m)	3
Speed(rpm)	2900
Max impeller diameter(mm)	183

Medium

Medium Name	Clear Water
Working temperature(°C)	20
Medium density(kg/m ³)	1000
Viscosity(mm ² /s)	1

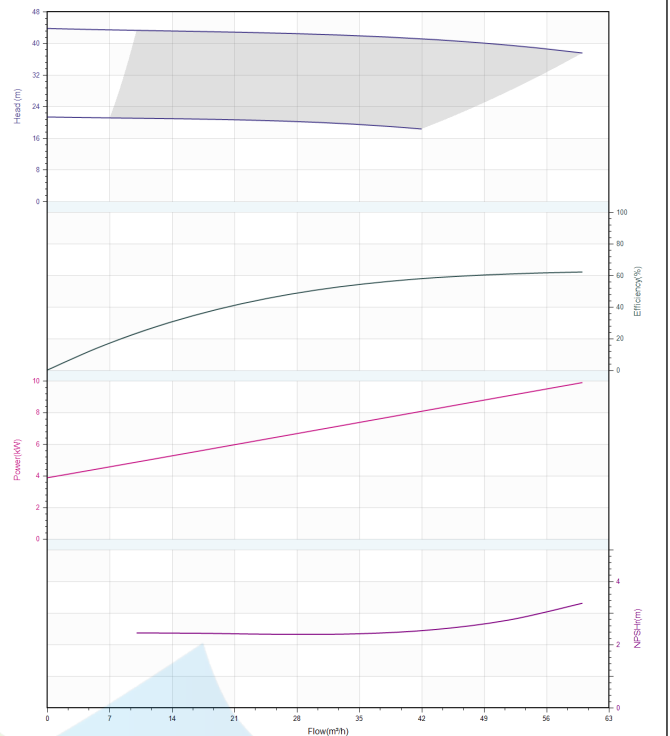



Structure picture
TD65-40/2

Manufacturer	CNP
Address	Yuhang District, Hangzhou,
Contact	86-571-88637351
Date	2022/03/09
Client Name	DPA
Client Addr.	
Contacts	Alireza
Contact	

Project Name	
Station Number	

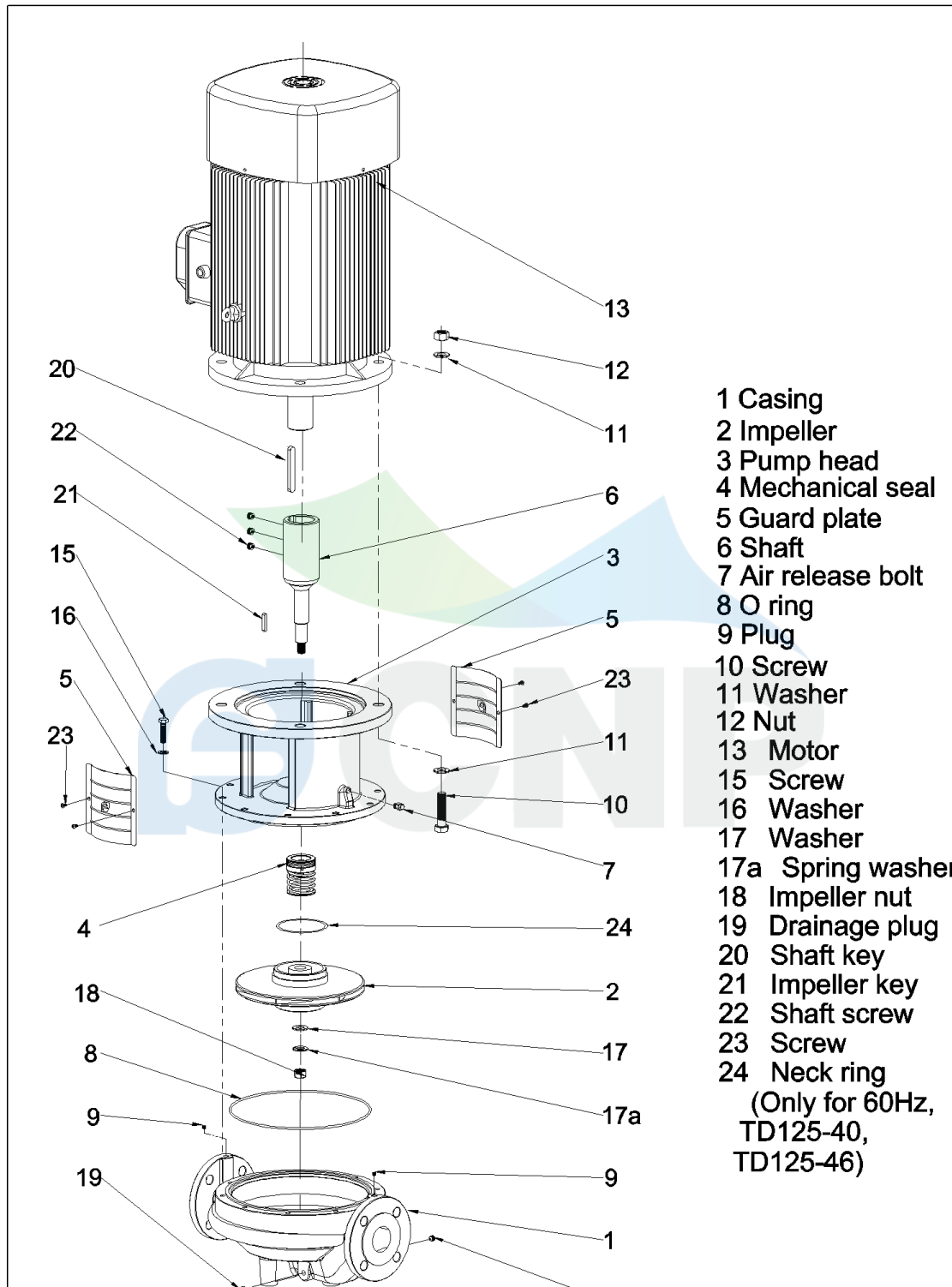

- 1 Casing
 - 2 Impeller
 - 3 Pump head
 - 4 Mechanical seal
 - 5 Guard plate
 - 6 Shaft
 - 7 Air release bolt
 - 8 O ring
 - 9 Plug
 - 10 Screw
 - 11 Washer
 - 12 Nut
 - 13 Motor
 - 15 Screw
 - 16 Washer
 - 17 Washer
 - 17a Spring washer
 - 18 Impeller nut
 - 19 Drainage plug
 - 20 Shaft key
 - 21 Impeller key
 - 22 Shaft screw
 - 23 Screw
 - 24 Neck ring
- (Only for 60Hz,
TD125-40,
TD125-46)

E-TD32~TD150-080701 Extension shaft



Size picture
TD65-40/2

Manufacturer	CNP
Address	Yuhang District, Hangzhou,
Contact	86-571-88637351
Date	2022/03/09
Client Name	DPA
Client Addr.	
Contacts	Alireza
Contact	

Project Name

Station Number

