	Product information TD200-50/4	Manufacturer	CNP
		Address	Yuhang District, Hangzhou,
Project Name		Contact	86-571-88637351
		Date	2022/03/09
Station Number		Client Name	DPA
		Client Addr.	
		Contacts	Alireza
		Contact	

Product No.	1100040669
-------------	------------

Product picture(Note:the picture may not be the same as the	Series description
	<p>Product introduction</p> <p>Single stage in-line centrifugal pumps,inlet and outlet are horizontal with top side pulled out structure and can be repaired without removing the pipelines.</p> <p>Performance and advantages</p> <p>Compact structure Maintenance convenience Low noise Both cast iron and stainless steel impeller are available</p> <p>Application range</p>

technology	
Pump rotator speed	1480
Pump version	Easy-disassemble Type
Material	
Impeller	HT200
Pump body	HT200
Rubber code	NBR
Installation	
Connection Code	F
Maximum Operation Pressure	PN12
Medium	
Medium Temperature	-15~110
Structure dimension	
Inlet & outlet size types	DN
Inlet & Outlet Bore	200
Rotation Direction	Clockwise rotation viewed from motor end
Motor	
Number of Motor Phase	Three Phase
Protection Class	IP55
Insulation Class	F
Motor Power	90
Power Frequency	50Hz
Rated Voltage (V)	380V
Energy Efficiency Level	IE3
Seal	
Mechanical Seal	TD5-48/BSE4
Others	
Weight (kg)	975



Performance Curve TD200-50/4

Manufacturer	CNP
Address	Yuhang District, Hangzhou,
Contact	86-571-88637351
Date	2022/03/09
Client Name	DPA
Client Addr.	
Contacts	Alireza
Contact	

Project Name

Station Number

Medium Name Clear Water , Temperature 20°C, Density 1000kg/m³, Viscosity 1mm²/s, (ISO99062012 Grande 3B)

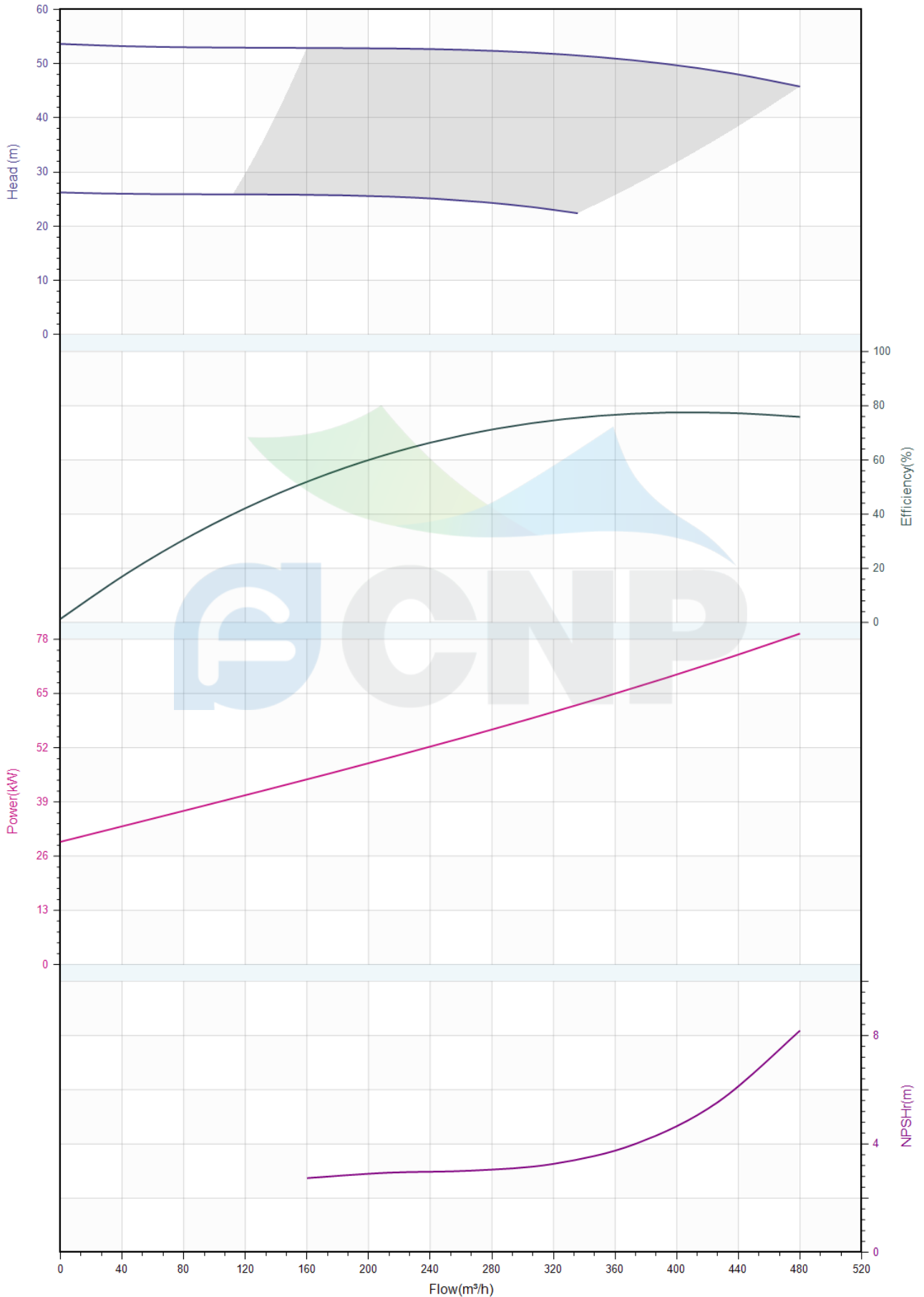



Pump technical parameters TD200-50/4

Manufacturer	CNP
Address	Yuhang District, Hangzhou,
Contact	86-571-88637351
Date	2022/03/09
Client Name	DPA
Client Addr.	
Contacts	Alireza
Contact	

Rated parameters

Pump model	TD200-50/4
Product No.	1100040669
Rated flow(m ³ /h)	400
Rated pressure(m)	50
Rated efficiency(%)	79
Power(kW)	69
NPSHr(m)	5.5
Speed(rpm)	1480
Max impeller diameter(mm)	396

Medium

Medium Name	Clear Water
Working temperature(°C)	20
Medium density(kg/m ³)	1000
Viscosity(mm ² /s)	1

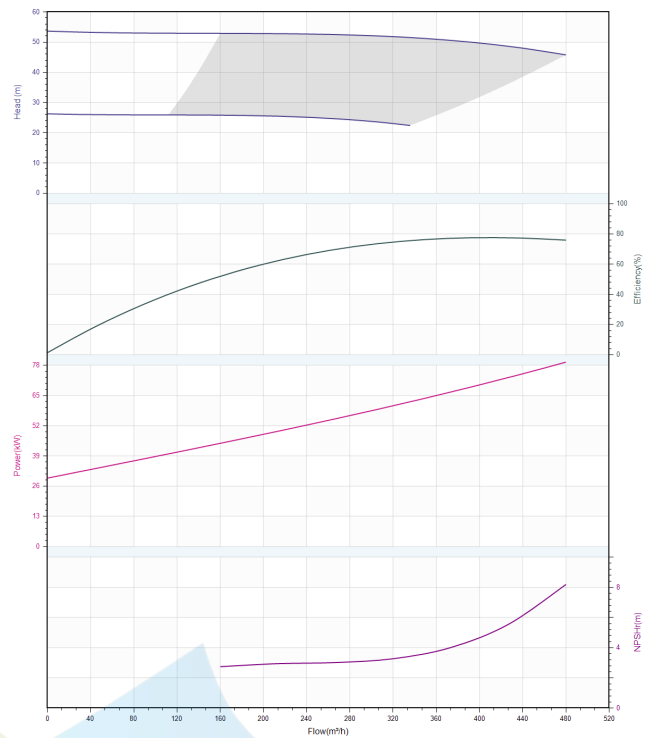



Structure picture TD200-50/4

Manufacturer	CNP
Address	Yuhang District, Hangzhou,
Contact	86-571-88637351
Date	2022/03/09
Client Name	DPA
Client Addr.	
Contacts	Alireza
Contact	

Project Name	
Station Number	

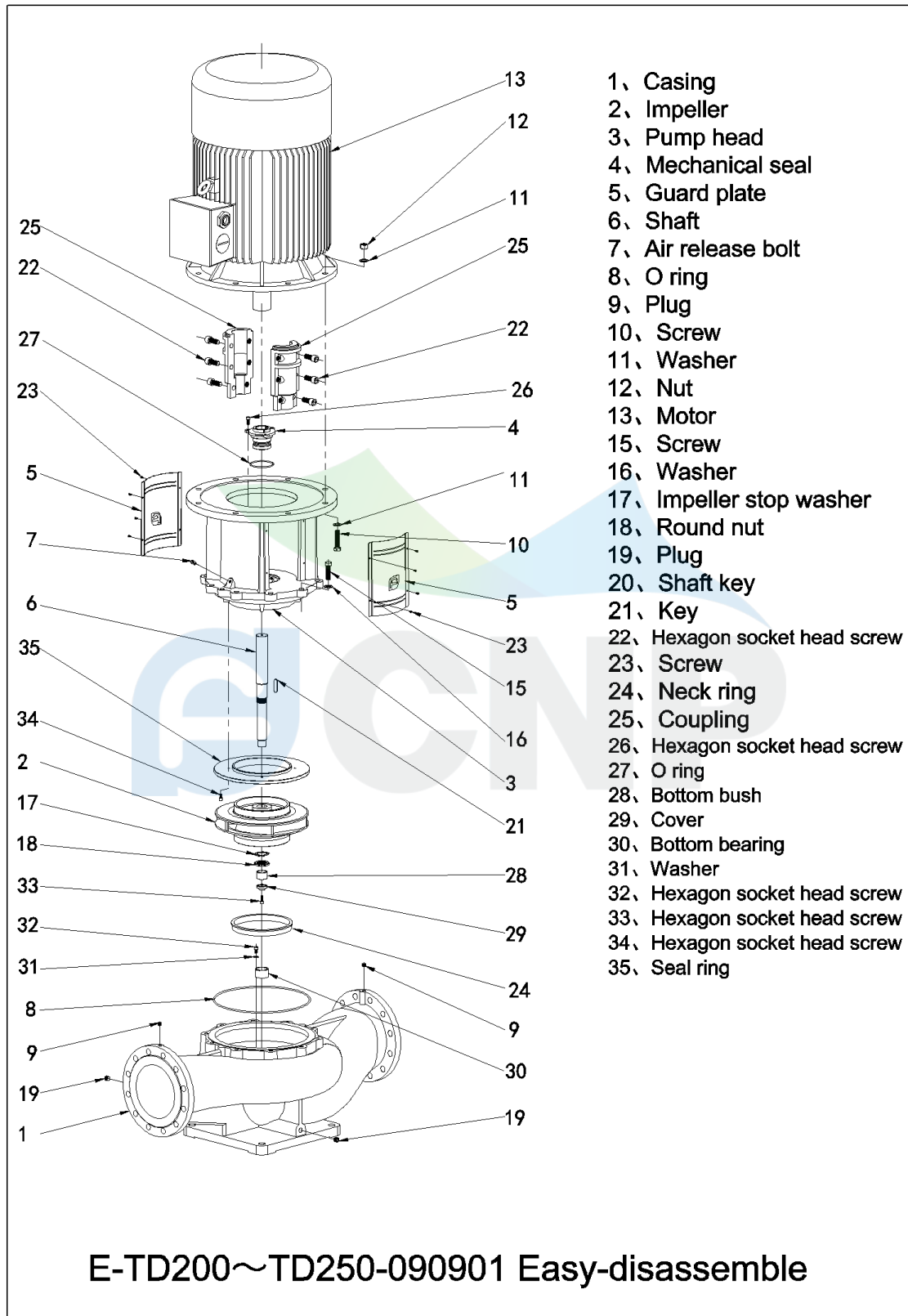



Size picture
TD200-50/4

Manufacturer	CNP
Address	Yuhang District, Hangzhou,
Contact	86-571-88637351
Date	2022/03/09
Client Name	DPA
Client Addr.	
Contacts	Alireza
Contact	

Project Name	
Station Number	

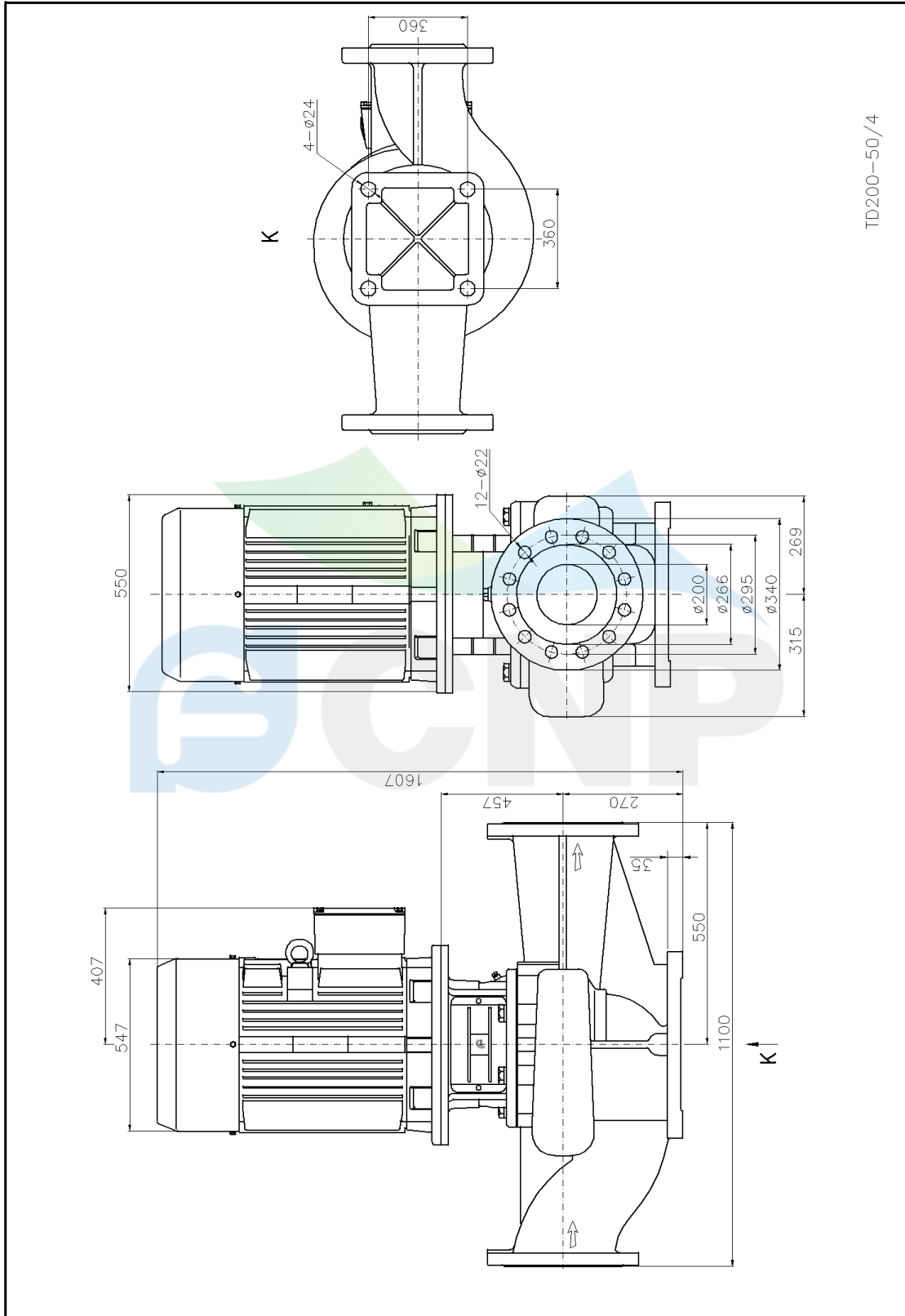

TD200-50/4