	Product information TD150-33/4	Manufacturer	CNP
		Address	Yuhang District, Hangzhou,
Project Name		Contact	86-571-88637351
		Date	2022/03/09
Station Number		Client Name	DPA
		Client Addr.	
		Contacts	Alireza
		Contact	

Product No.	1100040446
-------------	------------

Product picture(Note:the picture may not be the same as the	Series description
	<p>Product introduction</p> <p>Single stage in-line centrifugal pumps,inlet and outlet are horizontal with top side pulled out structure and can be repaired without removing the pipelines.</p> <p>Performance and advantages</p> <p>Compact structure Maintenance convenience Low noise Both cast iron and stainless steel impeller are available</p> <p>Application range</p>

technology	
Pump rotator speed	1480
Pump version	Extension shaft
Material	
Impeller	HT200
Pump body	HT200
Rubber code	NBR
Installation	
Connection Code	F
Maximum Operation Pressure	PN12
Medium	
Medium Temperature	-15~110
Structure dimension	
Inlet & outlet size types	DN
Inlet & Outlet Bore	150
Rotation Direction	Clockwise rotation viewed from motor end
Motor	
Number of Motor Phase	Three Phase
Protection Class	IP55
Insulation Class	F
Motor Power	30
Power Frequency	50Hz
Rated Voltage (V)	380V
Energy Efficiency Level	IE3
Seal	
Mechanical Seal	TD-40/BSE4
Others	
Weight (kg)	406



Performance Curve TD150-33/4

Manufacturer	CNP
Address	Yuhang District, Hangzhou,
Contact	86-571-88637351
Date	2022/03/09
Client Name	DPA
Client Addr.	
Contacts	Alireza
Contact	

Project Name

Station Number

Medium Name Clear Water , Temperature 20°C, Density 1000kg/m³, Viscosity 1mm²/s, (ISO99062012 Grande 3B)

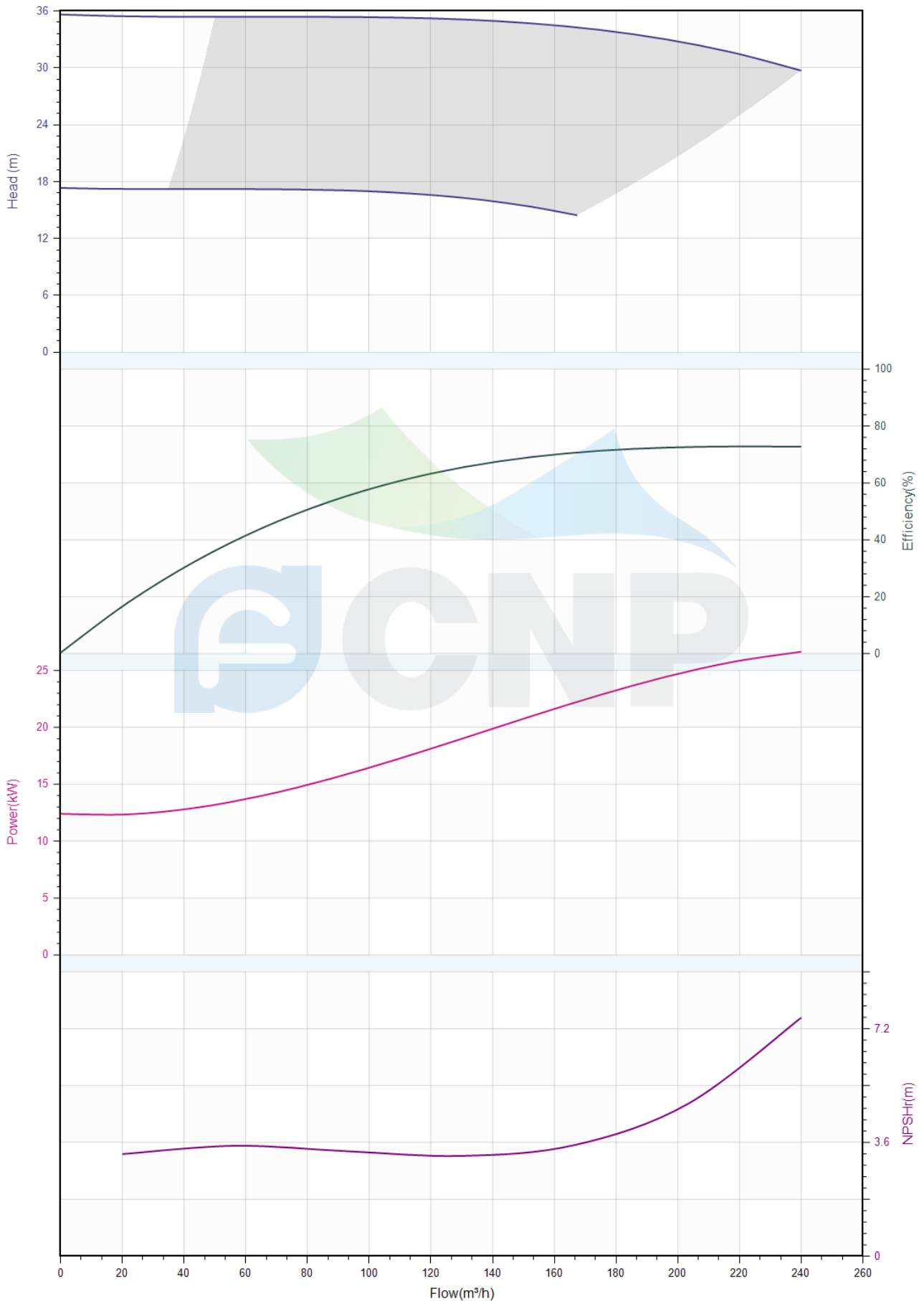



Pump technical parameters TD150-33/4

Manufacturer	CNP
Address	Yuhang District, Hangzhou,
Contact	86-571-88637351
Date	2022/03/09
Client Name	DPA
Client Addr.	
Contacts	Alireza
Contact	

Rated parameters

Pump model	TD150-33/4
Product No.	1100040446
Rated flow(m ³ /h)	200
Rated pressure(m)	33
Rated efficiency(%)	76
Power(kW)	24
NPSHr(m)	4
Speed(rpm)	1480
Max impeller diameter(mm)	324

Medium

Medium Name	Clear Water
Working temperature(°C)	20
Medium density(kg/m ³)	1000
Viscosity(mm ² /s)	1

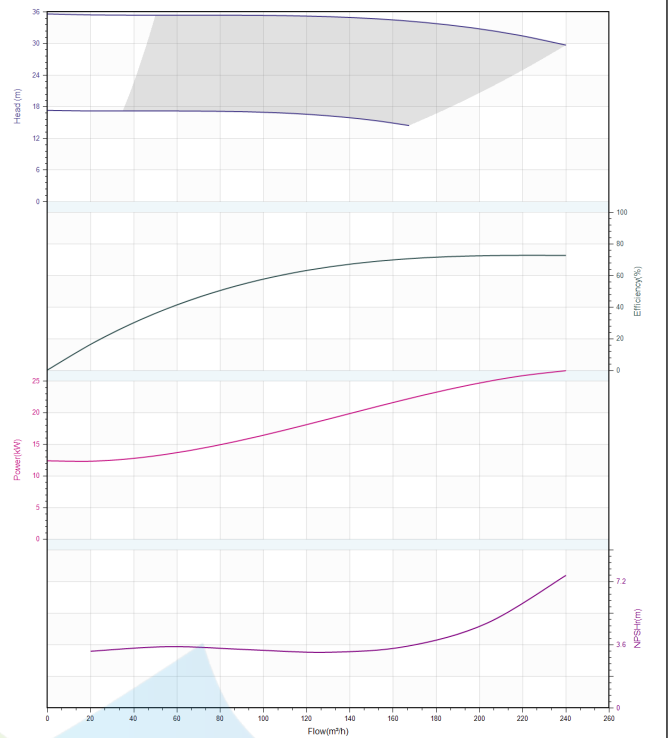



Structure picture
TD150-33/4

Manufacturer	CNP
Address	Yuhang District, Hangzhou,
Contact	86-571-88637351
Date	2022/03/09
Client Name	DPA
Client Addr.	
Contacts	Alireza
Contact	

Project Name	
Station Number	

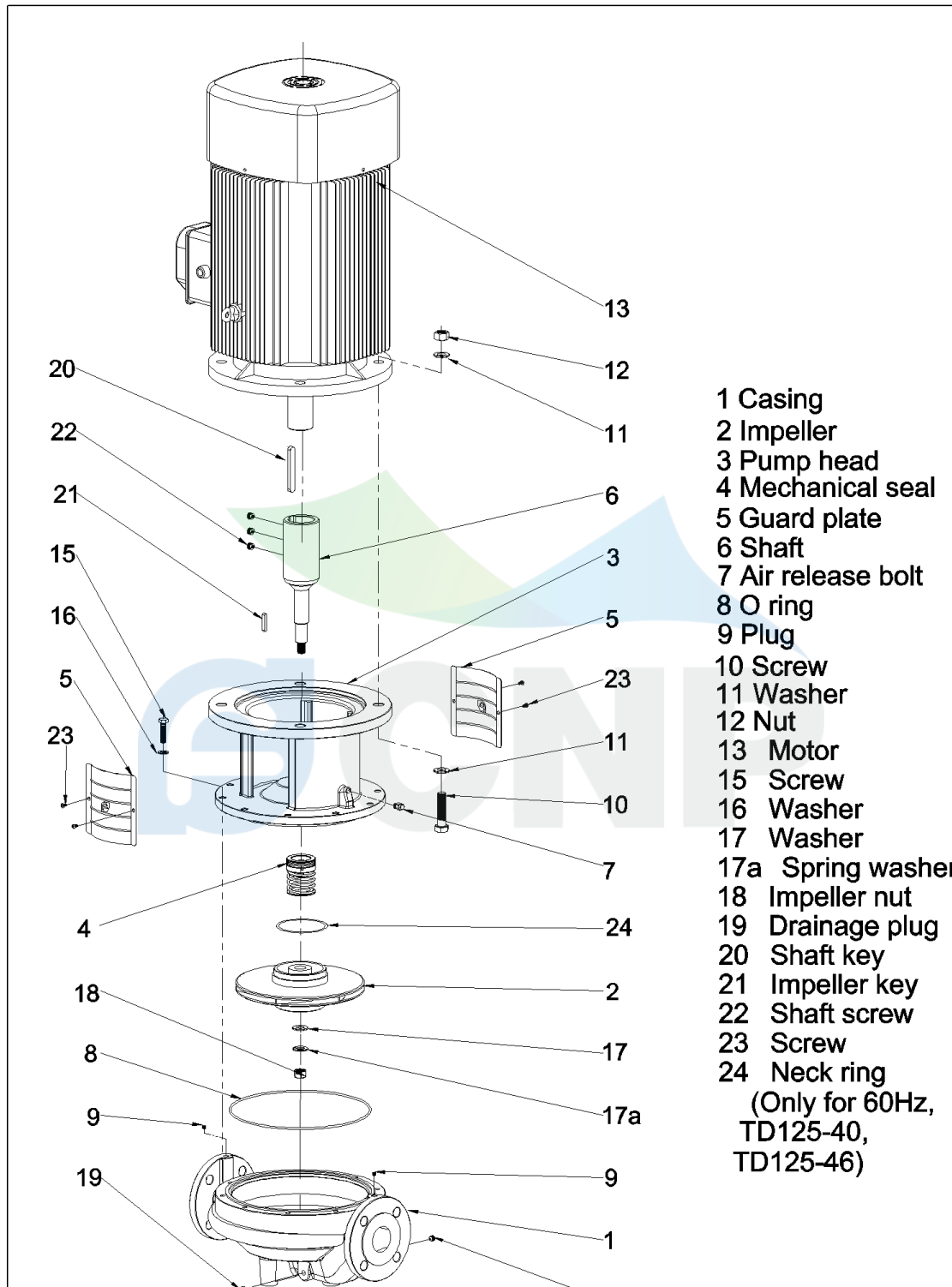

- 1 Casing
- 2 Impeller
- 3 Pump head
- 4 Mechanical seal
- 5 Guard plate
- 6 Shaft
- 7 Air release bolt
- 8 O ring
- 9 Plug
- 10 Screw
- 11 Washer
- 12 Nut
- 13 Motor
- 15 Screw
- 16 Washer
- 17 Washer
- 17a Spring washer
- 18 Impeller nut
- 19 Drainage plug
- 20 Shaft key
- 21 Impeller key
- 22 Shaft screw
- 23 Screw
- 24 Neck ring
(Only for 60Hz,
TD125-40,
TD125-46)

E-TD32~TD150-080701 Extension shaft



Size picture TD150-33/4

Manufacturer	CNP
Address	Yuhang District, Hangzhou,
Contact	86-571-88637351
Date	2022/03/09
Client Name	DPA
Client Addr.	
Contacts	Alireza
Contact	

Project Name

Station Number

