	Product Information ZS65-50-200/9.2	Manufacturer	CNP
		Address	Yuhang District, Hangzhou, Zhejiang,
Project Name		Contact	86-571-88637351
		Date	2022/03/09
Item NO		Client Name	DPA
		Client Addr.	
		Contacts	Alireza
		Contact	

Part NO.	1100043465
----------	------------

Product Picture	Note
	Stainless steel horizontal single stage centrifugal pump, pumpbody produced with stainless steel stamping, expanding and welding technology, can replace the traditional IS pump and general corrosion resistant pumps, axial inlet and radial outlet.

technology	
Pump rotator speed	2900
Nameplate standards	CE
Material	
Impeller	316
Rubber code	P
Material Code	L
Installation	
Maximum Operation Pressure	10bar
Maximum Altitude	1000m
Medium	
Maximum Environment Temper	40
Liquid Temperature Range	-20+100
Motor	
Number of Motor Phase	Three Phase
Protection Class	IP55
Insulation Class	F
Motor Power	9.2KW
Power Frequency	50HZ
Rated Voltage (V)	380V
Rated Current (A)	17.6
Energy Efficiency Level	IE3
Seal	
Mechanical Seal	ZS-24/BSE6
Others	
Weight (kg)	85

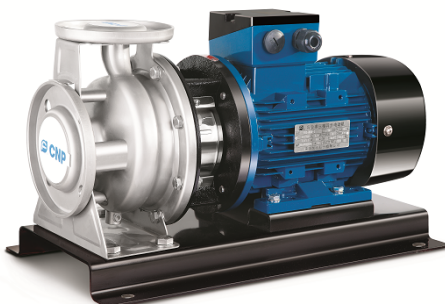

Performance Curve ZS65-50-200/9.2

Manufacturer	CNP
Address	Yuhang District, Hangzhou, Zhejiang,
Contact	86-571-88637351
Date	2022/03/09
Client Name	DPA
Client Addr.	
Contacts	Alireza
Contact	

Project Name

Item NO

The hydraulic performance curve have been tested with Clean Water at 20°C, density 1000kg/m³, and at 1bar atmospheric pressure. ISO99062012 Grade 3B

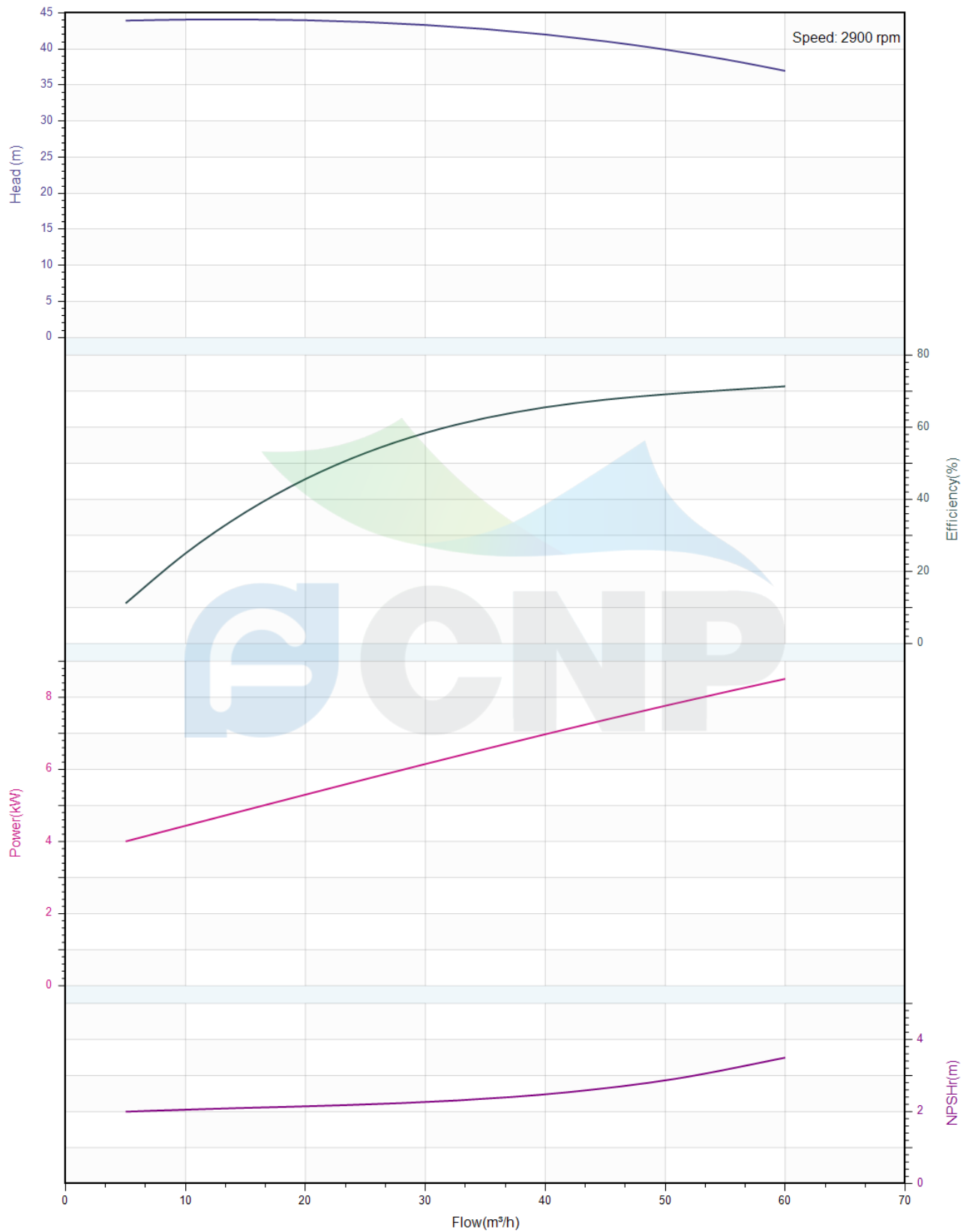



Pump Technical Parameters ZS65-50-200/9.2

Manufacturer	CNP
Address	Yuhang District, Hangzhou, Zhejiang,
Contact	86-571-88637351
Date	2022/03/09
Client Name	DPA
Client Addr.	
Contacts	Alireza
Contact	

Rated parameters

Pump model	ZS65-50-200/9.2
Part NO.	1100043465
Rated flow (m ³ /h)	50
Rated head (m)	40
Rated efficiency (%)	70
Power (kW)	7.79
NPSHr (m)	3.5
Speed (rpm)	2900
Max impeller diameter (mm)	181

Medium

Pumped medium	Clean Water
Working temperature (°C)	20
Medium density (kg/m ³)	1000
Viscosity (mm ² /s)	1

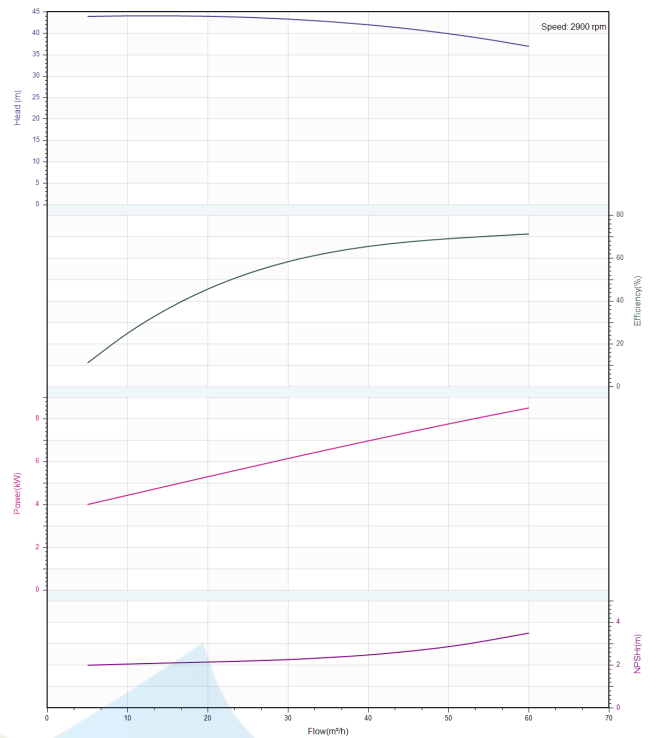



Structure picture
ZS65-50-200/9.2

Manufacturer	CNP
Address	Yuhang District, Hangzhou, Zhejiang,
Contact	86-571-88637351
Date	2022/03/09
Client Name	DPA
Client Addr.	
Contacts	Alireza
Contact	

Project Name

Item NO

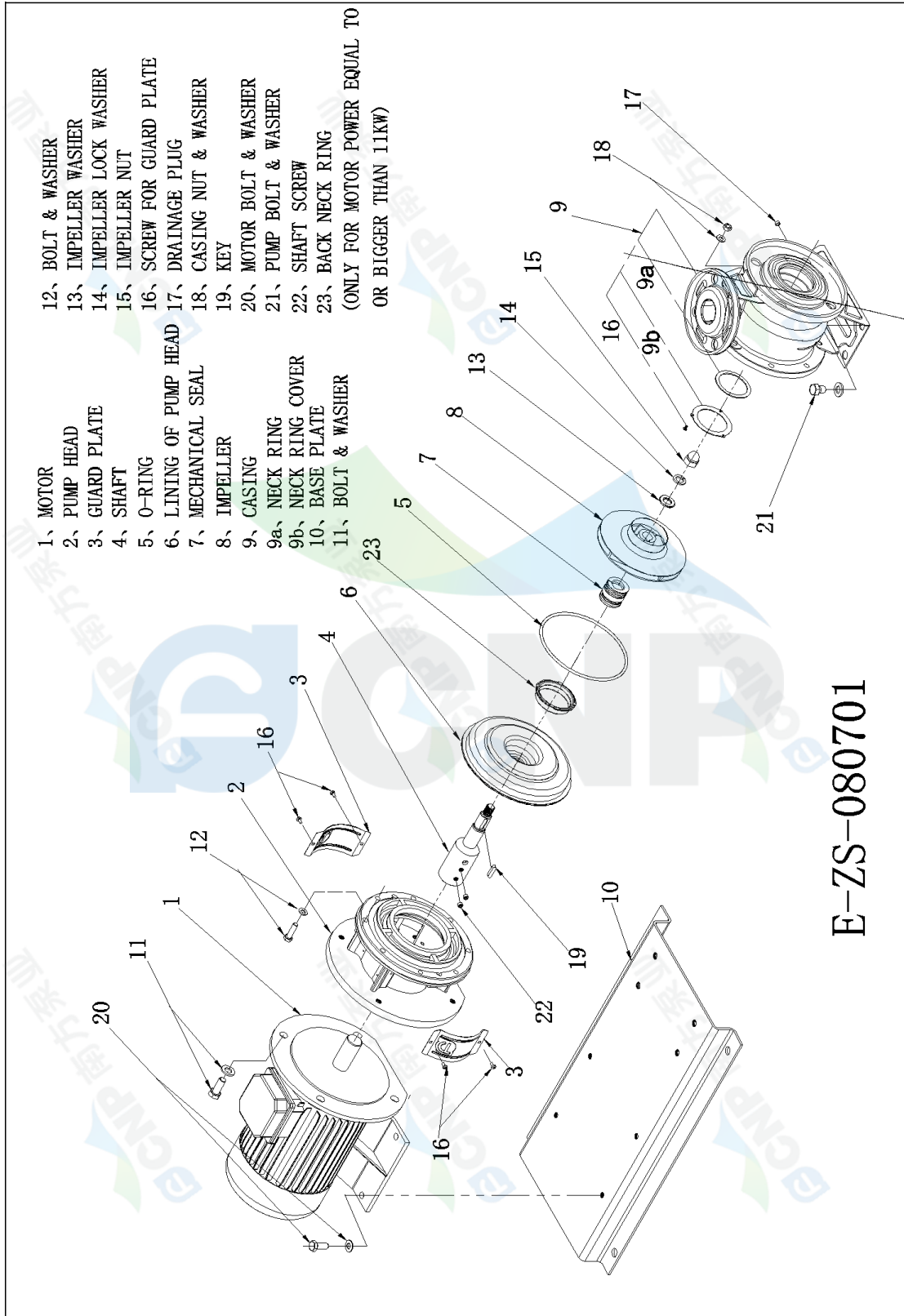

E-ZS-080701



Dimension Drawing ZS65-50-200/9.2

Manufacturer	CNP
Address	Yuhang District, Hangzhou, Zhejiang,
Contact	86-571-88637351
Date	2022/03/09
Client Name	DPA
Client Addr.	
Contacts	Alireza
Contact	

Project Name

Item NO

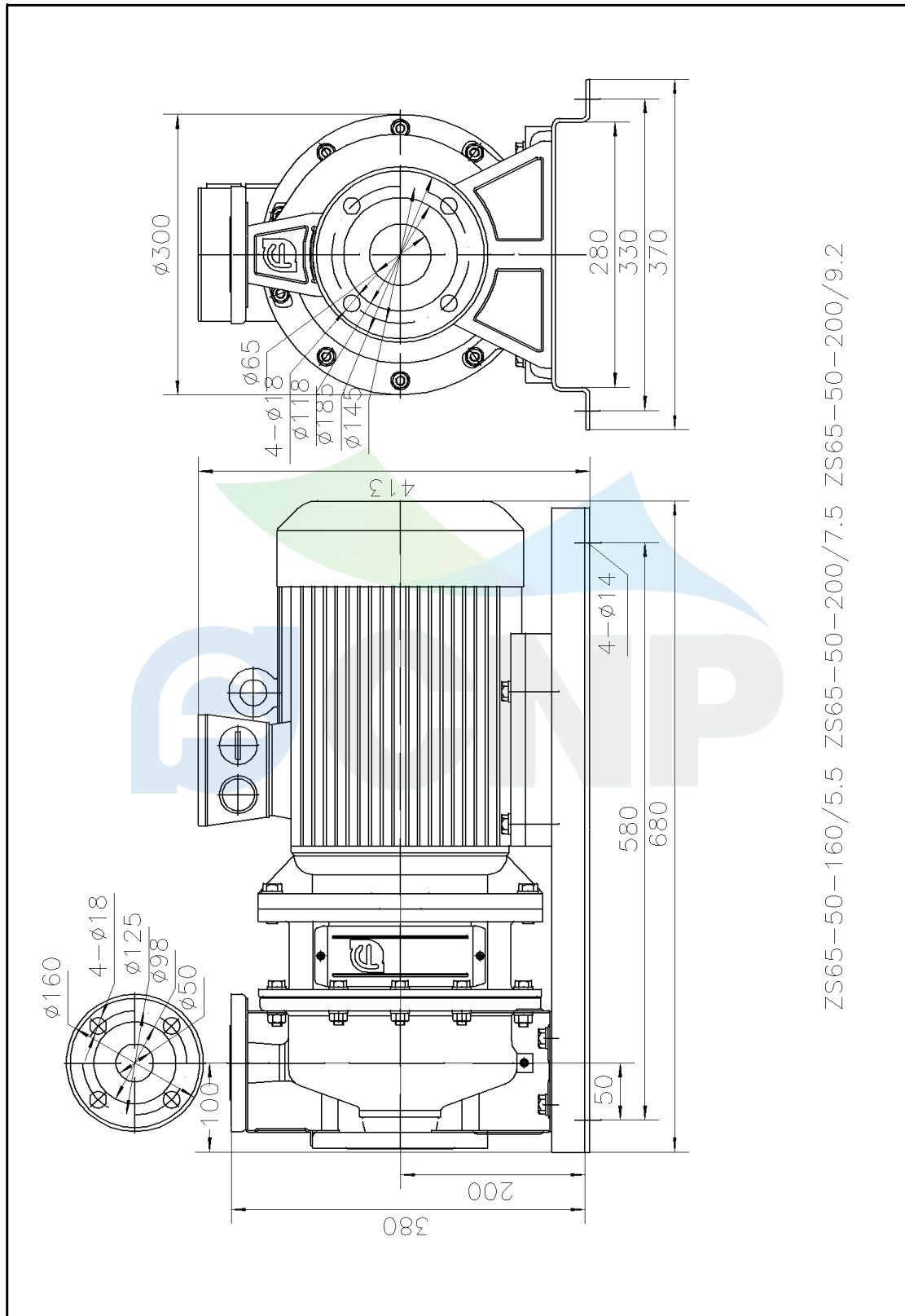

ZS65-50-160/5.5 ZS65-50-200/7.5 ZS65-50-200/9.2